

GMN

High Frequency Spindles for automatic tool change

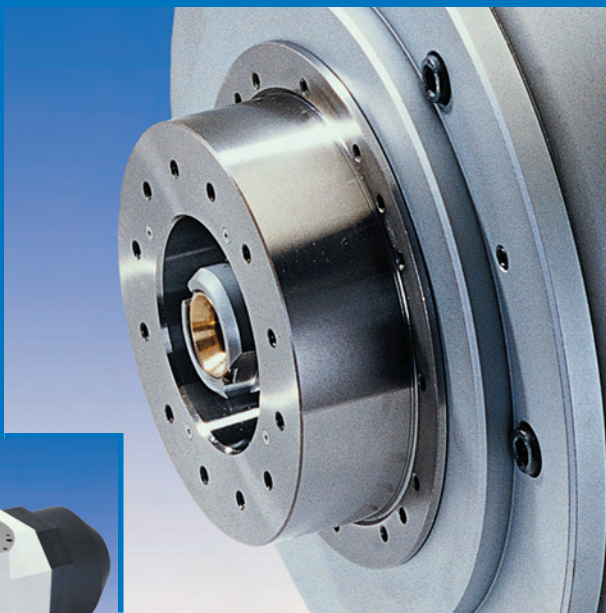

25050310

Spindle types - Overview	4
Design and features of HC-/HCS style	
Shaft output power	5
Integral encoders for closed loop control	
Advantages of hybrid ceramic bearings	6
Adjustable bearing preload	7
Vibration sensor	
Tool interface	8
Taper cleaning	
Clamping system	9
Position sensors	
Air purge	10
Fluid-Ring seal	
Coolant through shaft	11
Coolant through spindle housing	
Internal minimized coolant supply - Single-channel system	12
Internal minimized coolant supply - Two-channel system	13
A method for controlling axial shaft growth	14
Measurement of the axial shaft growth by sensor	
Pick-up spindle / Multi couplings	15
Spindle testing stand	16
Dimensions and characteristics of the spindle types	17 - 46

HC / HCS - Spindles

Page

	Spindle type		Housing diameter [mm]	Max. speed [rpm]	Output [kW]	From speed [rpm]	Torque [Nm]	Lubrication	Tool interface	Bearing W1 [mm]
17	HC	80 cg - 40000 / 3	80	40000	3	30000	0.96	g	HSK - E 25	30
18	HC	100 - 60000 / 5	100	60000	5	60000	0.8	OL	HSK - E 32	35
19	HCS	120 - 45000 / 15	120	45000	15	24000	6	OL	HSK - E 40	45
20	HCS	120 - 60000 / 10,5	120	60000	10.5	51000	2	OL	HSK - E 25	30
21	HCS	120 - 75000 / 10	120	75000	10	75000	1.3	OL	HSK - E 25	30
22	HCS	120 - 90000 / 4,4	120	90000	4.4	90000	0.47	OL	HSK - E 20	25
23	HCS	125 - 42000 / 15	125	42000	15	24000	6	OL	HSK - E 32	35
24	HCS	150 - 42000 / 30	150	42000	30	21000	14	OL	HSK - E 50	55
25	HCS	170 - 24000 / 41	170	24000	41	7000	56	OL	HSK - A 63	70
26	HCS	170 - 30000 / 40	170	30000	40	7000	55	OL	HSK - A 63	70
27	HCS	170 - 40000 / 39	170	40000	39	18000	21	OL	HSK - E 50	55
28	HCS	170 g - 15000 / 20	170	15000	20	7000	27	g	HSK - A 63	70
29	HCS	200 - 42000 / 10	200	42000	10	15000	6	OL	HSK - A 50 / - E 50	55
30	HCS	230 - 12000 / 30	230	12000	30	1600	179	OL	HSK - A 100	110
31	HCS	230 - 24000 / 18	230	24000	18	3150	57	OL	HSK - A 63	70
32	HCS	230 - 24000 / 120	230	24000	120	13800	83	OL	HSK - A 80	90
33	HCS	230 - 30000 / 120	230	30000	120	13800	83	OL	HSK - A 63 / - F 80	70
34	HCS	230 - 40000 / 22	230	40000	22	10000	21	OL	HSK - E 50	55
35	HCS	230 g - 10000 / 24	230	10000	24	2500	92	g	HSK - A 63	90
36	HCS	230 g - 16000 / 24	230	16000	24	6000	38	g	HSK - A 63	70
37	HCS	230 g - 16000 / 40	230	16000	40	4500	85	g	HSK - A 63	70
38	HCS	260 - 12000 / 40	260	12000	40	1350	298	OL	HSK - A 100	110
39	HCS	270 g - 10000 / 94	270	10000	94	2000	450	g	HSK - A 100 / SK 50	110
40	HCS	280 - 18000 / 60	280	18000	60	3300	174	OL	HSK - A 100	110
41	HCS	285 - 12000 / 40	285	12000	40	1680	227	OL	HSK - A 100	110
42	HCS	285 g - 4000 / 24	285	4000	24	300	750	g	HSK - A 100	110
43	HCS	300 - 12000 / 30	300	12000	30	1000	270	OL	HSK - A 100	110
44	HCS	300 - 14000 / 45	300	14000	45	1560	275	OL	HSK - A 100	110
45	HCS	310 - 12000 / 25	310	12000	25	930	257	OL	HSK - A 100	110
46	HCS	320 - 8000 / 40	320	8000	40	1050	380	OL	SK 50	110

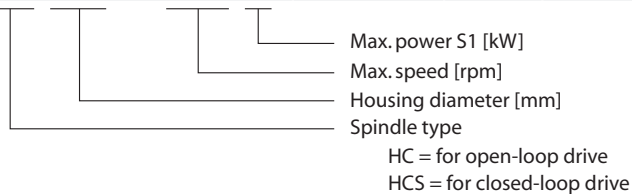

W1 = Bore diameter of front bearings
 OL = Oil/air lubrication
 g = Permanent grease lubrication
 SK = ISO taper
 HSK = Hollow tapered shank

Preference type

Please ask if spindle drawing is required. We send it as dxf file.

Shaft Output Power

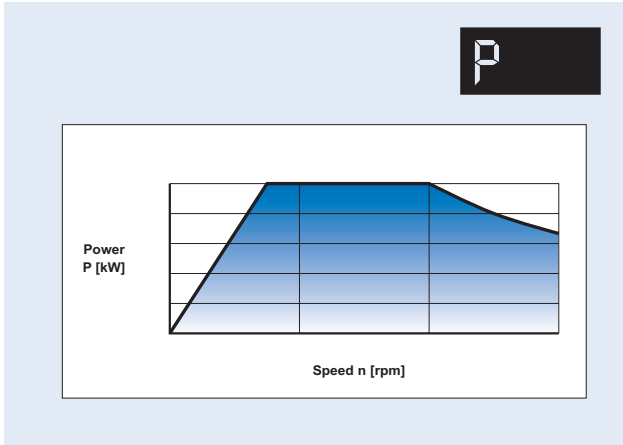

Chip removal rates are defined by the material's specific cutting speeds. Generally small tool diameters require high speeds and larger tools are operated at lower speeds. Large tools require high torque while small tools require less torque, but higher speeds.

Integral motors utilized in the HC/HCS style spindle meet these requirements. The "field weakening" characteristics provide the high torque at lower speed.

The spindles can be operated in the following modes:

- ▶ S1
Continuous power
- ▶ S6
Continuous duty with intermittent loading, a duty factor of 60% (S6-60%) for a cycle time of 2 minutes.

Depending on the application requirements, the motor characteristics curve of power / torque relative to speed can be met.

Rigidity is a prerequisite for the volume of metal to be removed and the surface finish required. This requires large shaft diameters, and accordingly large spindles, thereby large motors can be utilized.

Due to the advances in motor development, the power density has been increased to such an extent that in many cases the output power far exceeds the application requirements.

Oversized systems are costly, due to the size of the frequency inverter's required to operate them.

Therefore operating the spindles at the required power level, the capacity of the inverter determines the power profile.

Integral Encoders For Closed Loop Control

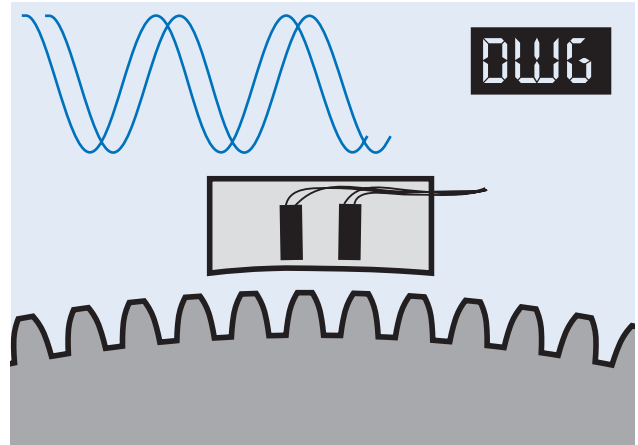

Incorporating high resolution encoders into spindles, provides feedback and control of the actual shaft speed, and angular position of the shaft, at all times.

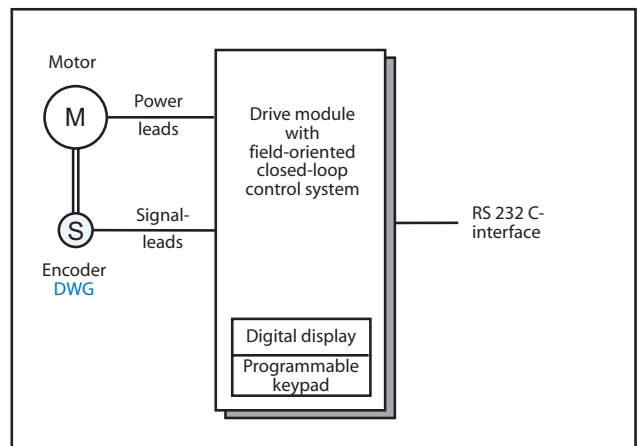

The advantages are as follows:

- ▶ Smooth precise rotation and control at low speed
- ▶ "C"-axis operation e.g. thread cutting
- ▶ Shaft positioning within 0.001 degree
- ▶ The drives high dynamic performance at full capacity, combined with the quick acceleration and deceleration times, allows the systems full power capacity to be utilized.

GMN can interface the encoders to meet the selected drive systems requirements.

The encoder system consists of a precision gear mounted to the rotating spindle shaft and a stationary sensor in the spindle housing readily accessible, for ease of service.

GMN will optimize the performance of the complete spindle and drive package before shipment, and provide all the necessary parameters.

Advantages Of Hybrid Ceramic Bearings

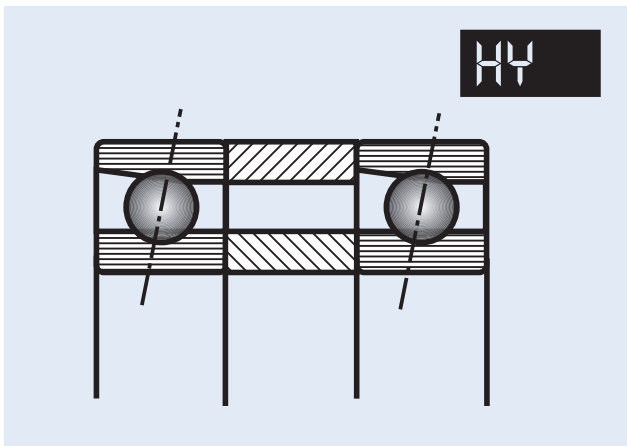

GMN "HC/HCS" series high frequency spindles utilize hybrid ceramic ball bearings. These bearings have standard steel bearing races and are matched with silicon nitride balls.

Advantages of Hybrid bearings compared with normal spindle bearings are:

Reduced wear

The high degree of hardness of the balls, and the nongalling effect of the silicon nitride against metallic material lessens the wear. This is especially important in cases of minimal lubrication. In addition, wear particles will not embed themselves into the balls to further damage of the races.

Rigidity

Modulus of elasticity is bigger than steel, which increases the static and dynamic stiffness. The increase in dynamic rigidity depends on the ratio of bearing preload to the centrifugal force on the balls.

Friction

Because of the reduced spin-rolls ratios and lower Hertzian stresses, friction and respectively operating temperatures are reduced.

Axial shaft movement

As a result of the lightweight ceramic balls, centrifugal forces are reduced with a corresponding reduction in dynamic movement of bearing races. In addition, movements due to less friction and the lower coefficient of expansion of ceramics are reduced.

Reliability of operation

The low thermal coefficient of expansion of the ceramic balls lessens the reduction of the radial running fits in the bearings. These fits are less variable at higher temperature differences between races.

Vibrations

Radial forces and the moments acting on the bearings produce displacement between the balls and the retainer. Hybrid bearings reduce this effect and produce a positive influence on cage vibrations and stresses.

Fatigue life

The fatigue life is comparable when the Hertzian stress on the contact surfaces between rings and balls is similar. As a result of the minor weight of the ceramic balls the Hertzian stress is lower.

Therefore hybrid bearings achieve longer life time.

Accuracy

Spindles of HC family are fitted with bearings produced according to GMN standard grade UP. They are distinguished from international standards due to excellent running accuracy.

Radial runout of assembled bearing inner ring
Limits in micron

Bearing bore diameter [mm]	Tolerance class		
	P4/ABEC 7	P2/ABEC 9	UP
> 2.5..10	2.5	1.5	1.5
> 10...18	2.5	1.5	1.5
> 18...30	3.0	2.5	1.5
> 30...50	4.0	2.5	2.0
> 50...80	4.0	2.5	2.0

Assembled bearing outer ring face runout with raceway
axial runout - Limits in micron

Bearing outside diameter [mm]	Tolerance class		
	P4/ABEC 7	P2/ABEC 9	UP
> 6... 8	5.0	1.5	2.0
> 18... 30	5.0	2.5	2.0
> 30... 50	5.0	2.5	2.0
> 50... 80	5.0	4.0	3.0
> 80...120	6.0	5.0	3.0

Adjustable Bearing Preload

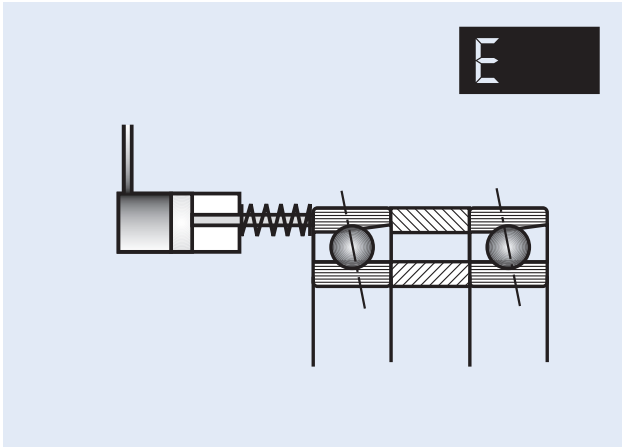

Bearing arrangement and preload determine the rigidity, and influence the life time of the spindle system.

For small speed ranges, and low speed operation the different versions of a solid preload arrangement are suitable.

Large speed range variances, and high speed spindles, require a systems that will not allow the bearing preload to be influenced by either temperature or speed. These applications require spring preloading of the bearings.

The above mentioned arrangements cannot be adjusted or changed, without disassembling the spindle.

With the "Adjustable bearing preload" system the bearing preload can be optimized to the application, and prolong the lifetime of the spindle.

The base preload of the bearings is determined by the highest speed requirements, and is set by spring preloading.

The optimized settings over the speed range is varied through an internal piston which is actuated via either hydraulic or pneumatic pressure.

As further advantage of the adjustable preload system is reduction of vibration.

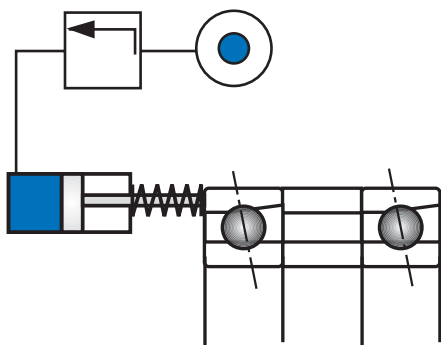

Vibration Sensor

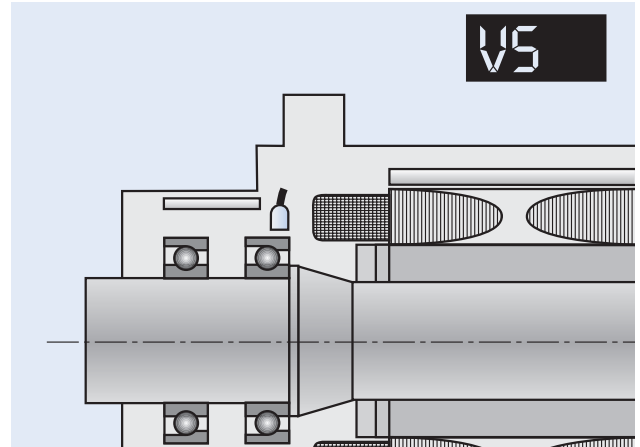

Unmonitored vibration can cause major damage to the spindle, machine tool and component being machined. GMN can provide sensors close to the front bearing set, which will quickly recognize any unbalance or high resonance which can cause catastrophic damage and shut-down the machine, or can plot out the curve on a display unit for analyzation and correction of the process or problem.

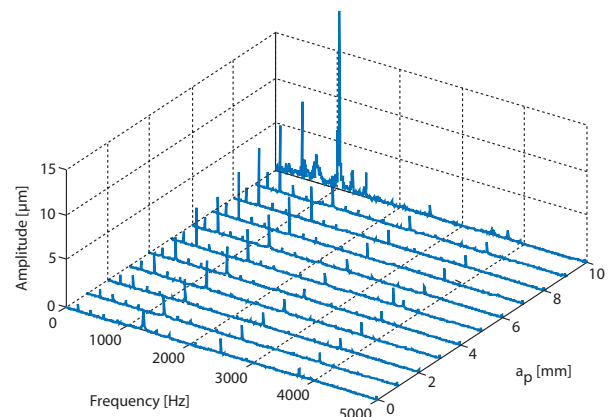

Source: FAG

The illustration shows a spike in the vibration spectrum at 1000 Hertz at a 10 mm depth of cut. This vibration could be from extreme cutting loads, unbalanced tooling, or damaged spindle bearings.

Tool Interface

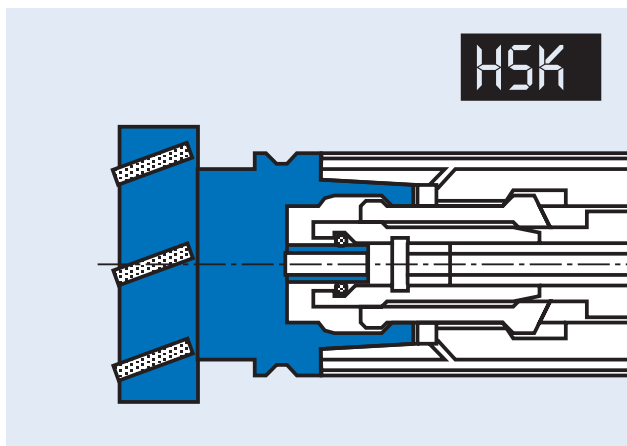

GMN can provide high frequency spindles to accept common tooling interface configurations.

The preferred HSK style offers the following advantages versus the ISO taper:

- ▶ High static and dynamic rigidity
- ▶ High tool change accuracy and repeatability
- ▶ Low axial movement during speed variations
- ▶ Increased pull-in force as the speed increases
- ▶ High torque transmission
- ▶ Increase in personal safety due to the internal drive dogs (Form A/C)

"Hollow tapered shanks with flat contact surfaces" are standard per [DIN 69893](#). The different "FORMS" of a particular size are based on a similar shank size dimension. The tool flange is dictated by the mode of tool change.

HC/HCS style spindles allow the use of tools with hollow shanks, type A, E or F according to interface design.

Form E was developed for high speed without drive dogs. The torque transmission is actuated by adherence.

Form A can also be used with manual tool change system provided in the HSP style spindles. This reduces the need for additional tool holders.

Tools according to Form B/D cannot be used in the HC/HCS spindle, they are designed for different applications.

Taper Cleaning

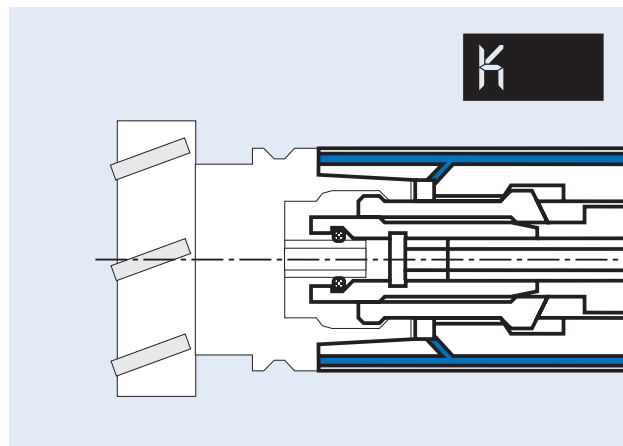

The high demand to precision requires excellent cleanliness at the tool interface. Automatic tool changing system call also for automatic cleaning systems.

ISO taper cleaning can be operated at the taper surfaces whereas the HSK request also treatment of the plane face when the size it accepts.

In accordance to the interface size different systems can be used:

- ▶ Only air
- ▶ Air or coolant in one line
- ▶ Air and coolant in separate lines

Clamping System

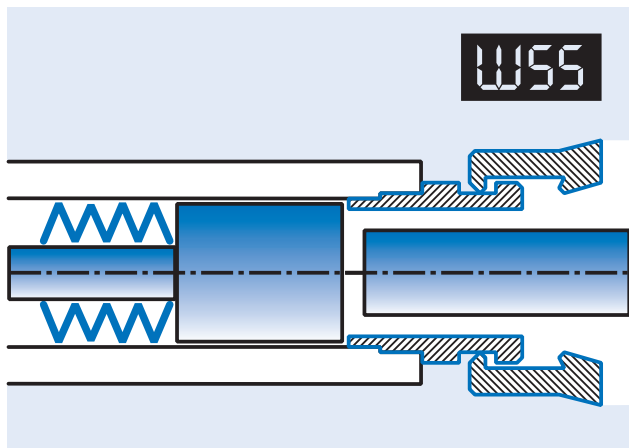

Both the ISO taper style and the "HSK" hollow shank tool holders are clamped via a set of gripper fingers. The clamping forces are generated through a spring washer pack, included in the power drawbar.

The centrifugal forces exerted by the balls in the pressure intensifier, multiplies the pull in force on an ISO taper style system. It is also speed dependent.

Increases in the pull in force for the HSK style tool clamping system is by the centrifugal forces on the internal gripping mechanism.

Tool un-clamping on either system is accomplished by actuating an internal piston with either hydraulic or pneumatic pressure.

An internal cylinder mounted at the rear of a spindle, along with a gripping mechanism supports the shaft during unclamping, to prevent the pressure exerted through the shaft from damaging the spindle bearings. During operation the gripping mechanism is disconnected.

These designs provide low vibration and a high safety factor for high speed quick change tool clamping systems.

Position Sensors

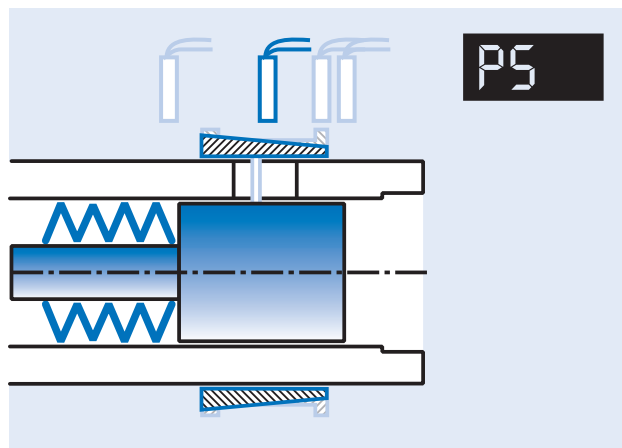

The GMN spindles are equipped with proximity sensors to allow for proper, trouble free operation during tool changing.

► Tool change

Depending on the size and nominal speed of the spindle, a variety of sensor arrangements can be applied for feed back to the machine control, about the tool changing cycle.

Variation A

Depending on the internal space constraints the drawbar can be monitored for "tool clamped", "unclamped", "clamped no tool", with one analog sensor or three inductive proximity switches.

Variation B

A two sensor arrangement for monitor the position of the piston, either "forward" or "back".

► Rotation of shaft

If the spindle size and speed restrict the use of an encoder, GMN can provide alternative sensors for actual shaft speed, and also "zero speed".

Air Purge

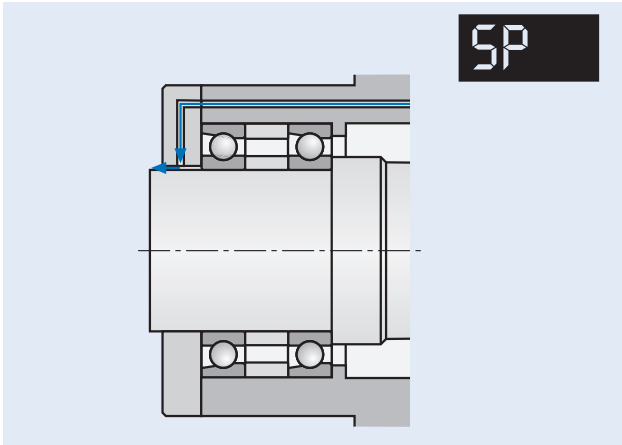

Pressurized air is used to prevent the ingress of contamination into the bearing system.

A continuous flow of clean dry air fills the closely machined gaps between the stationary and rotating members of the spindle.

The air stream also stops the spent oil lubrication from existing at the front of the spindle and away from the work piece.

Coolant Through Shaft

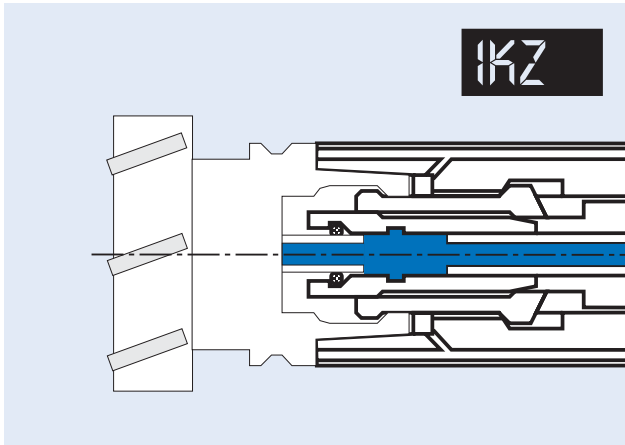

The internal coolant supply provides cooling directly to the cutting edge also at difficult form of workpieces.

In accordance to the interface size and dependent on the maximum operating speed different systems can be used:

- ▶ Only air
- ▶ Air or coolant in one line
- ▶ Air and coolant in separate lines

Coolant Through Spindle Housing

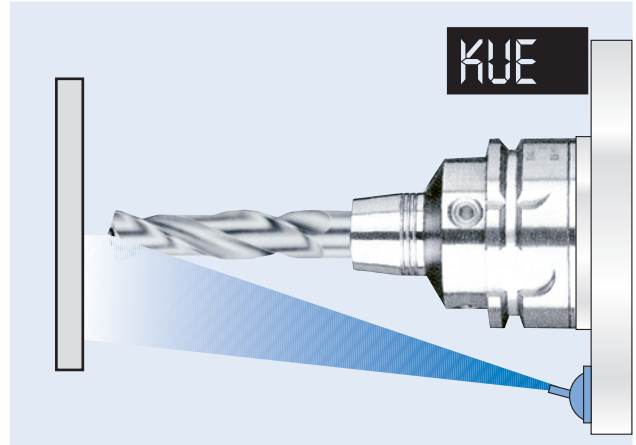

For cooling of tool and workpiece the medium is supplied through spindle housings and nozzels to the cutting surfaces.

Compressed air, cooling lubricant/air mixture or cooling lubricant can be used.

The representation below is with cooling lubricant as medium.

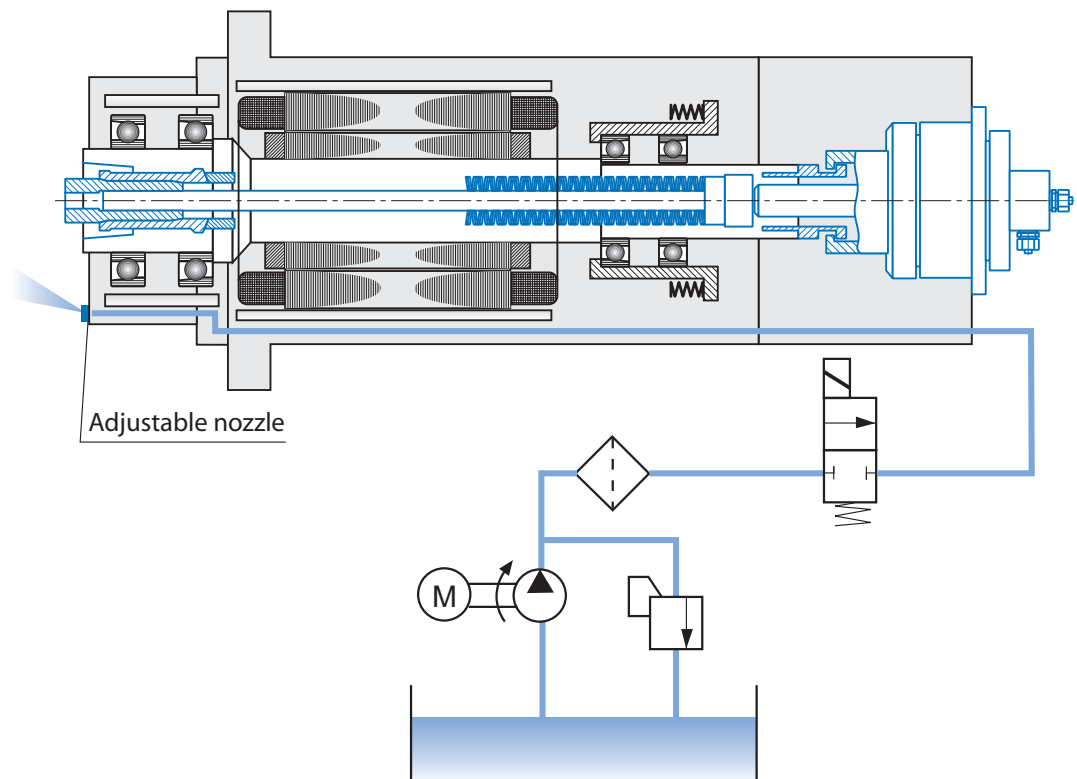

Internal Minimized Coolant Supply Single-Channel System

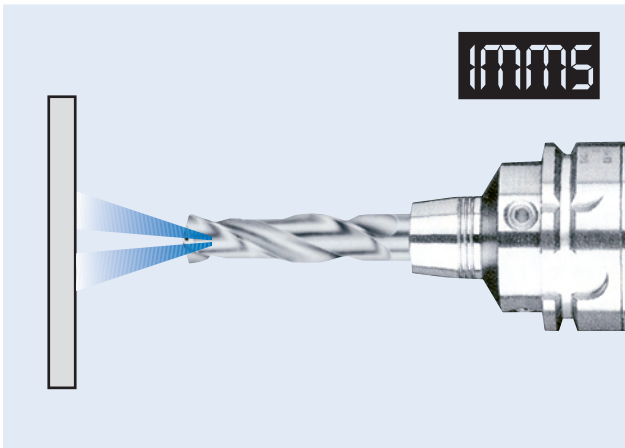

Characteristics of single-channel minimized coolant supply:

- ▶ Superfine oil mist (aerosol)
- ▶ Speed limitation due to aerosol decomposition
- ▶ For standard rotary unions
- ▶ For tools with coolant bore diameter > 1 mm
- ▶ In comparison with two-channel system longer reaction times at quantity changings
- ▶ For machines with less tool changes

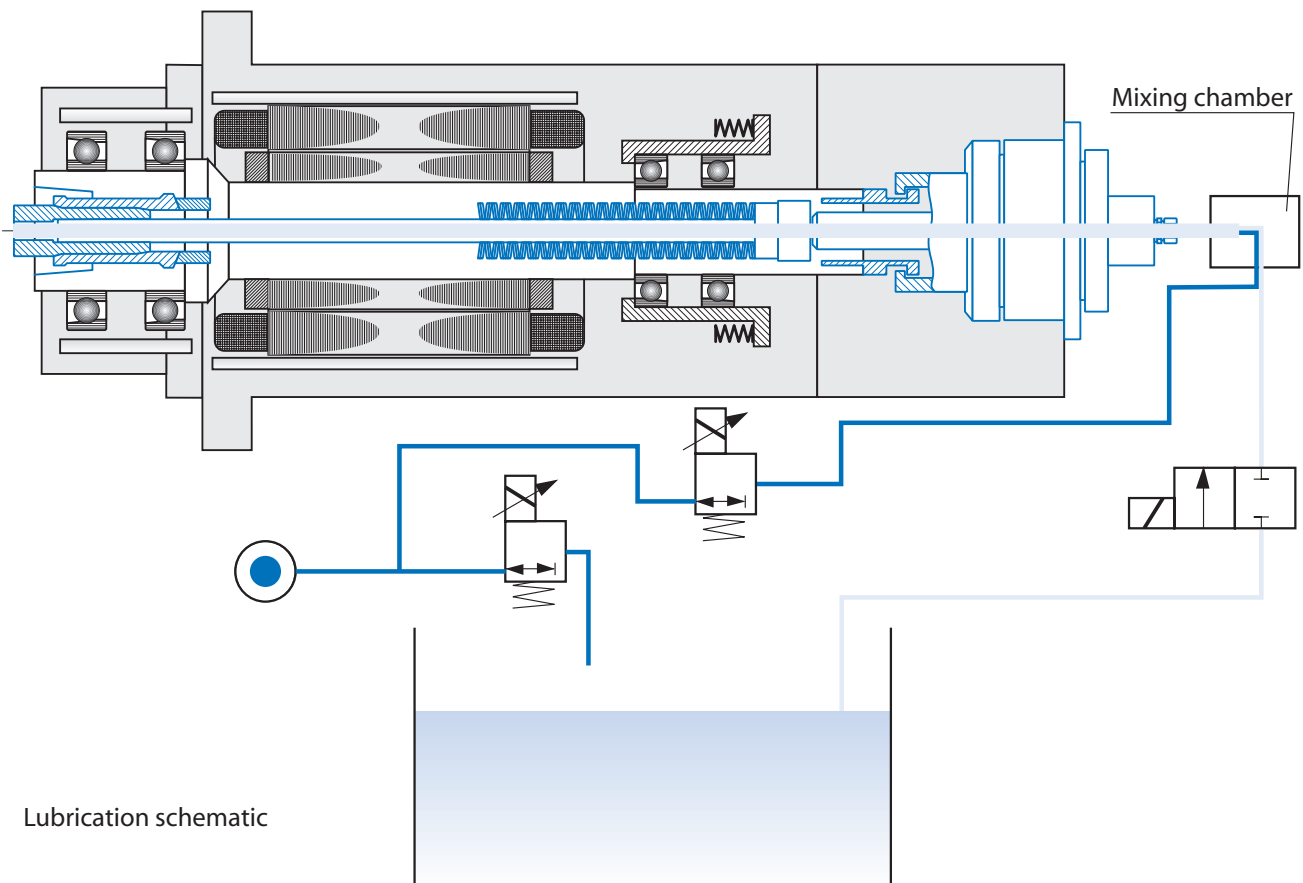

Internal Minimized Coolant Supply Two-Channel System

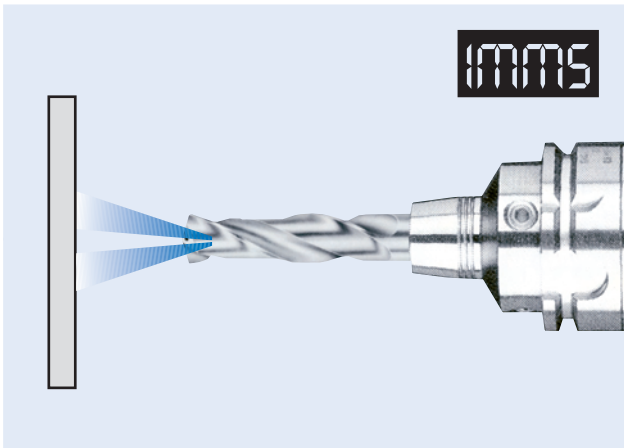

Characteristics of two-channel minimized coolant supply:

- ▶ No oil mist
- ▶ Oil and air mixable in almost any quantities or only air supply
- ▶ In comparison with single-channel system higher speeds possible
- ▶ For tools with high lubricant consumption
- ▶ For machines with more tool changes

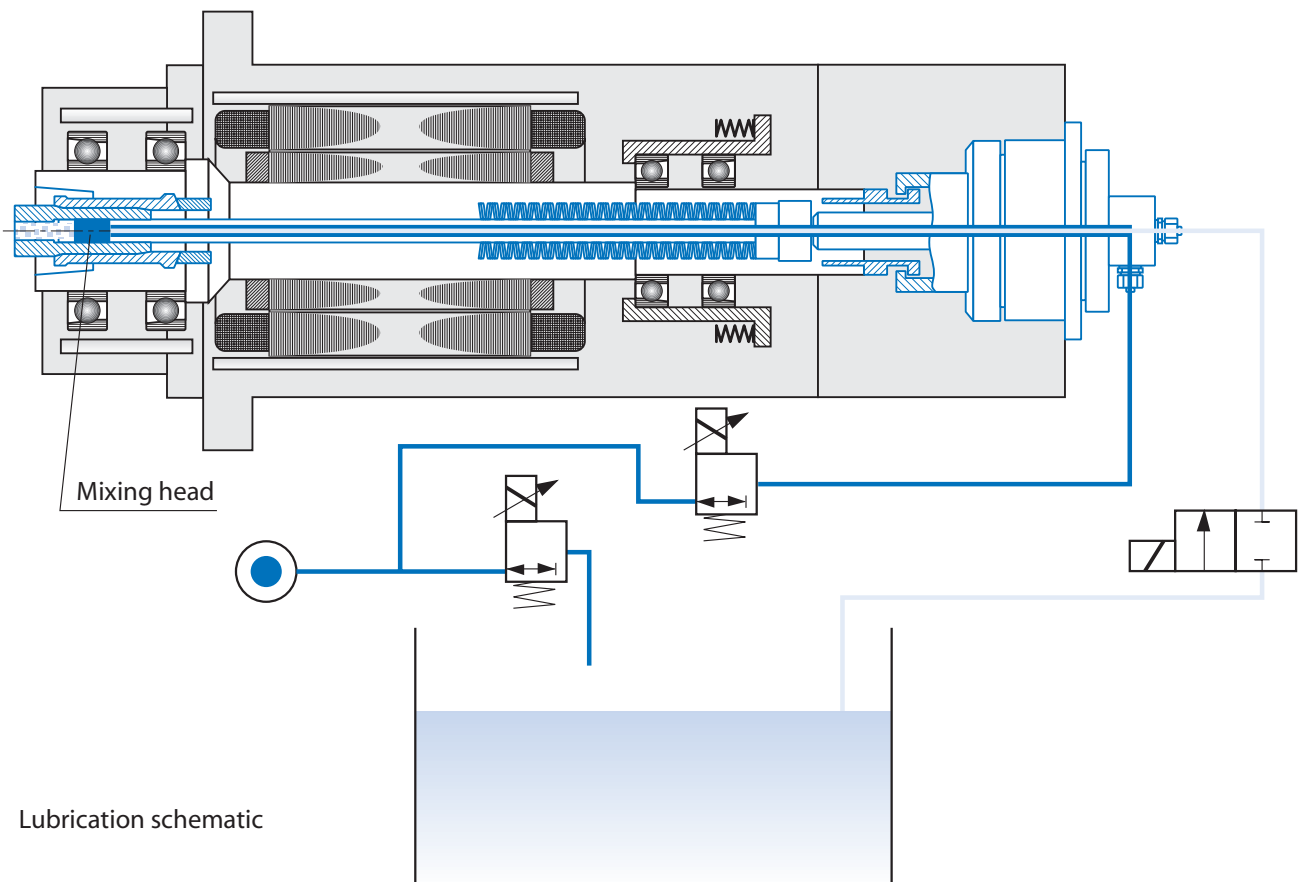

A Method For Controlling Axial Shaft Growth

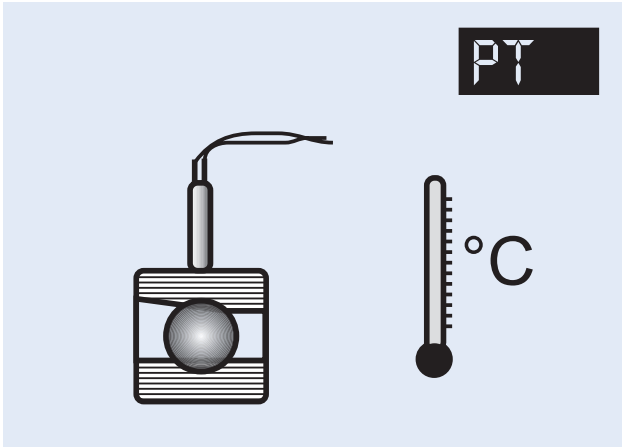

Precision machining requires the position of the cutting edge of the tool to be maintained. Temperature variations and centrifugal forces at the balls and bearing races, can cause axial movement of the tool mounting face of the shaft.

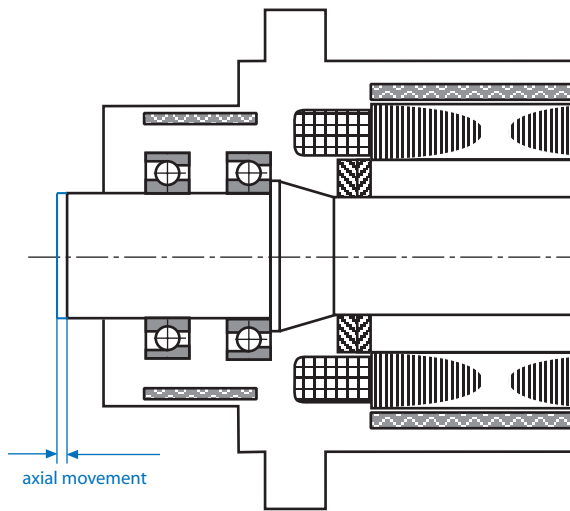

The "centrifugal forces" factor can be calculated and the speed dependent shaft movement can be compensated by through the machine tool control.

Measuring the shaft temperature at the bearing during operation is difficult.

Experience has shown that by measuring the temperature at outer diameter of the bearings, approximate temperature variations can be established and the axial movement compensated for.

Measurement Of The Axial Shaft Growth By Sensor

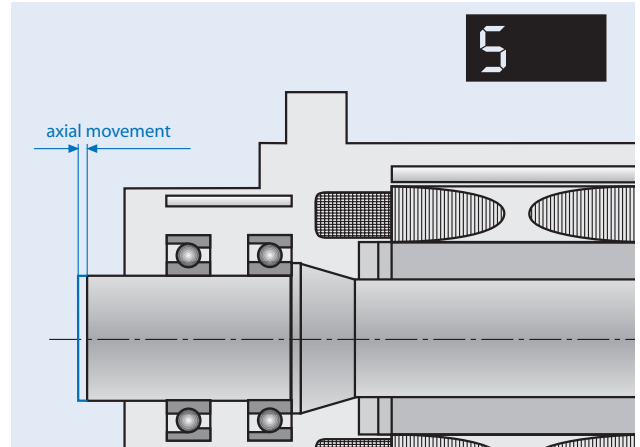

Axial shaft growth which is caused by fluctuations in temperature, can produce process errors in milling applications. GMN can incorporate a sensor at the front of the spindle to record the exact growth and the CNC machine control can compensate for the movement.

The measuring system which consists of an electronic controller which conditions the signal provided by the sensor has data storage capacity which provides immediate response after spindle exchange.

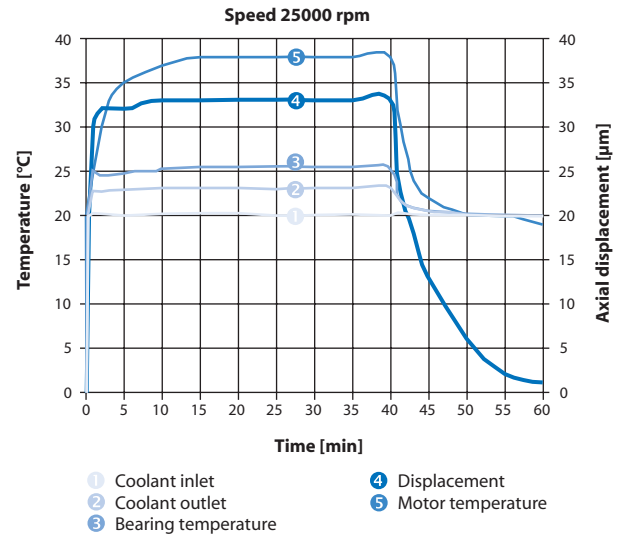

The diagram illustrates the axial shaft growth of a spindle operating at 25000 rpm.

Pick-up Spindle ★ Multi Couplings

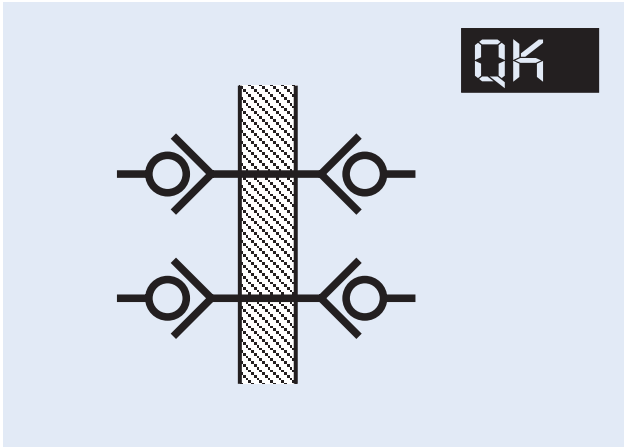

GMN spindles can be supplied with multi-couplings for energy and fuel supply.

This reduces the unproductive spindle replacement times, or - depending on the design - can even make possible the automatic replacement of spindles, thus increasing the flexibility of the machine.

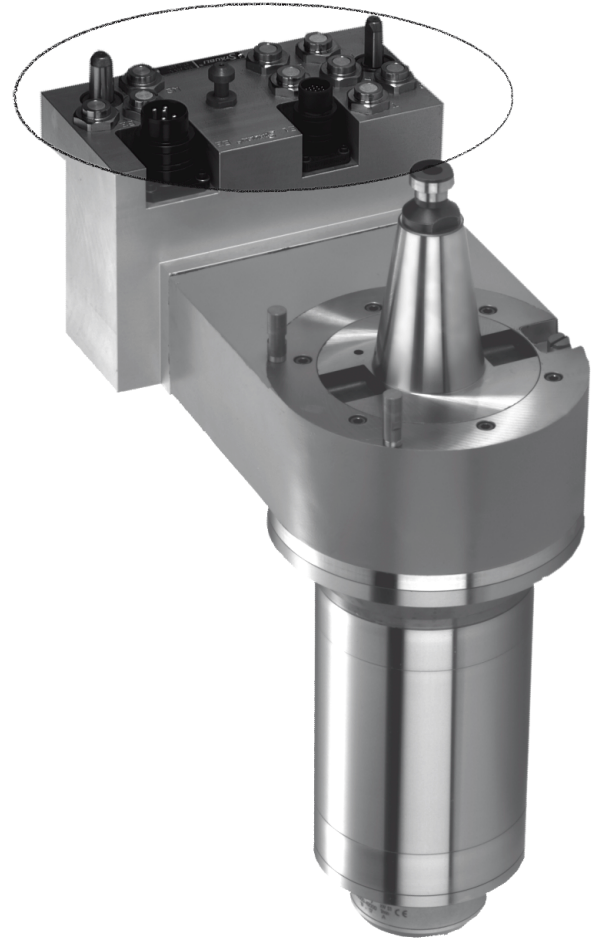

Quick Couplings

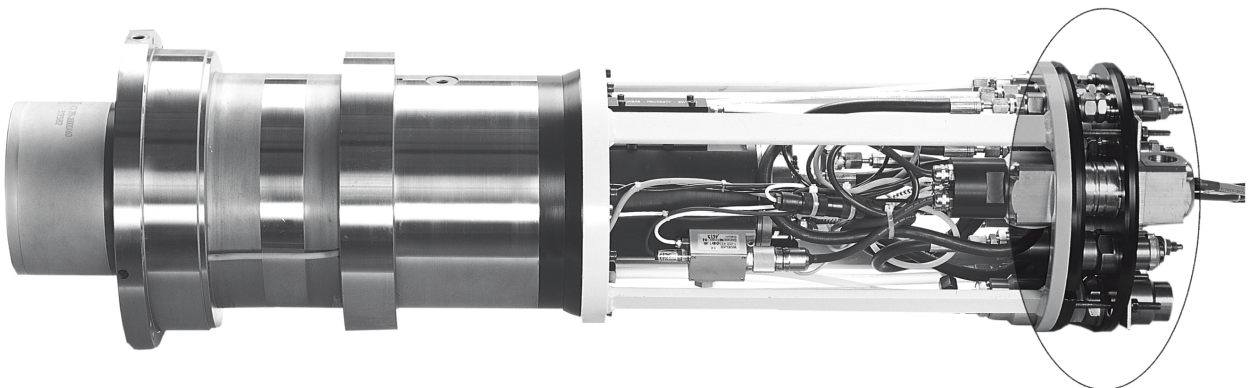

Spindle Testing Stand



Before GMN machine spindles for high speed machining (HSC) are delivered, they are tested on a test stand specially developed for GMN. One reason for this is that motor spindles become more and more complex and on the other hand their reliability is guaranteed by this. The test in which the setpoints as well as cycle and switching times are specified runs automatically. Finally a test certificate is produced in which all measured values are documented.

2 motor spindles with different parameters can be tested simultaneously.

Here it was proven that 180 cycles are sufficient to guarantee the highest possible reliability.

In every cycle the spindle is turned to maximum speed in a specified time within seconds, the shaft encoder signals are checked, the spindle is braked under defined conditions after a certain time, the tool change is performed and the signals of the position sensors are measured.

The position of the tool clamping system can be determined optionally analogously or through individual switches.

Furthermore the following are acquired: motor current, voltage in the windings, temperature of the winding and of the foremost bearing and, depending upon spindle equipment, functioning of coolant supply through the shaft and the adjustable bearing preload.

HC 80cg - 40000/3

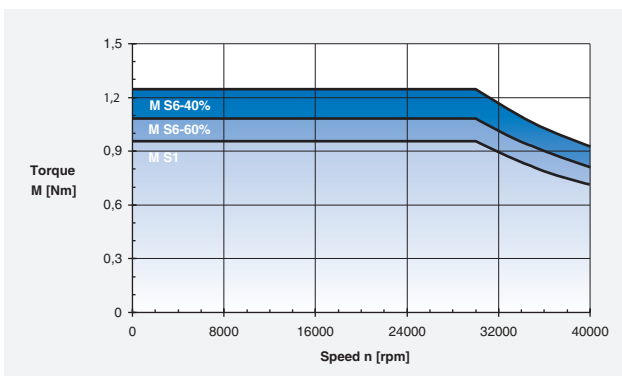
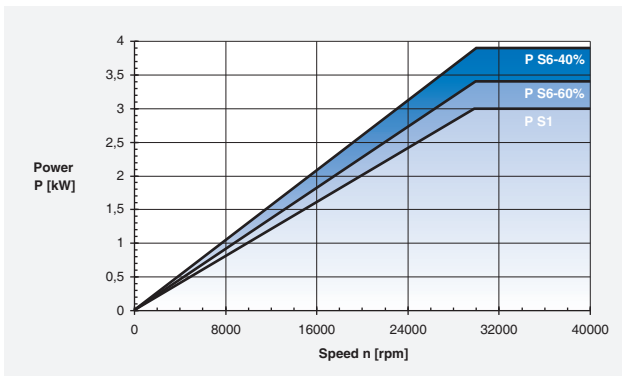
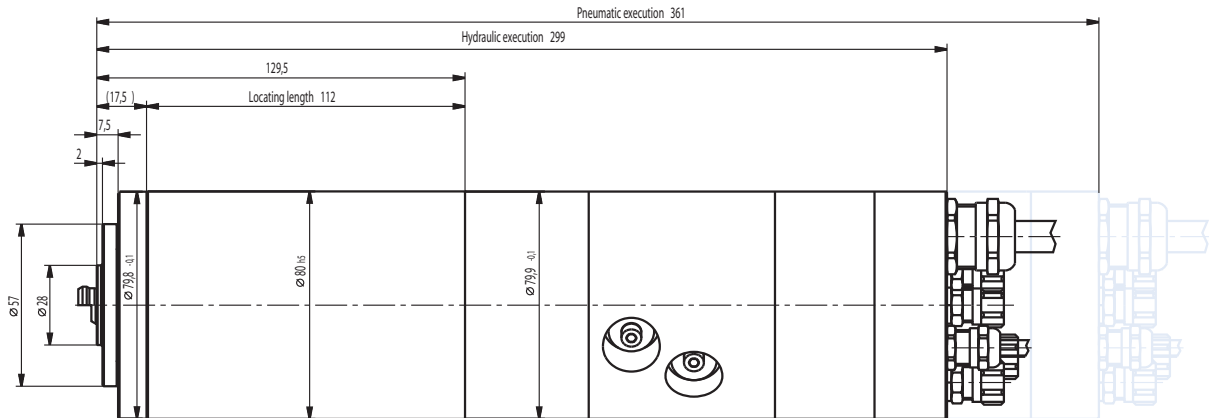

Synchronous motor

Power P (S1)	3 kW at 30,000 rpm
Torque M (S1)	0.96 Nm
Speed n_{max}	40,000 rpm
Drive	open-loop

Hybrid ball bearings

Bore diameter	
of front bearings	30 mm
Lubrication	Grease

Tool interface

Interface	HSK-E 25
Monitoring	
"clamped", "unclamped"	Analog sensor
Taper cleaning	Air
Static tool pull-in force	2.8 kN
Tool release	Hydraulic or pneumatic

Seal

Rigidity

Radial	41 N/ μ m
Axial	50 N/ μ m

Also available for oil/air lubrication.
This lubrication possibly leads to increase of speed.

HC 100 - 60000/5

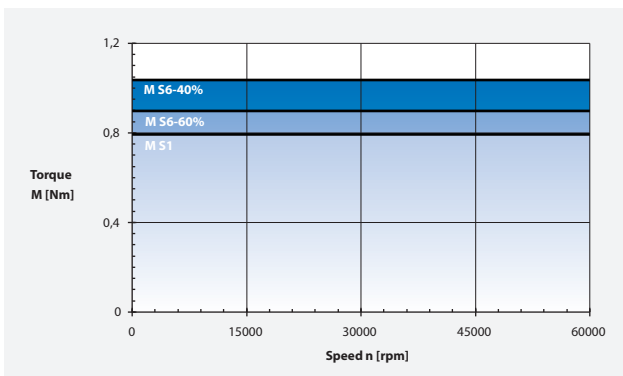
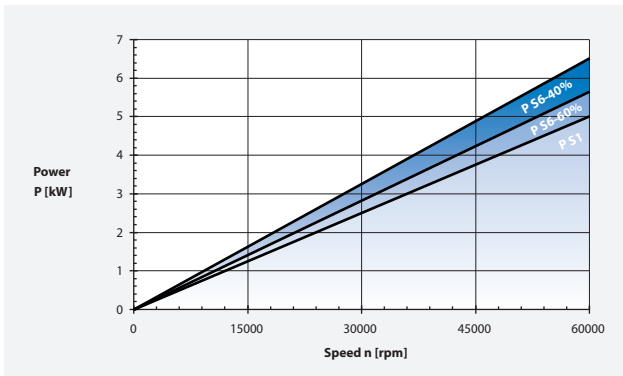
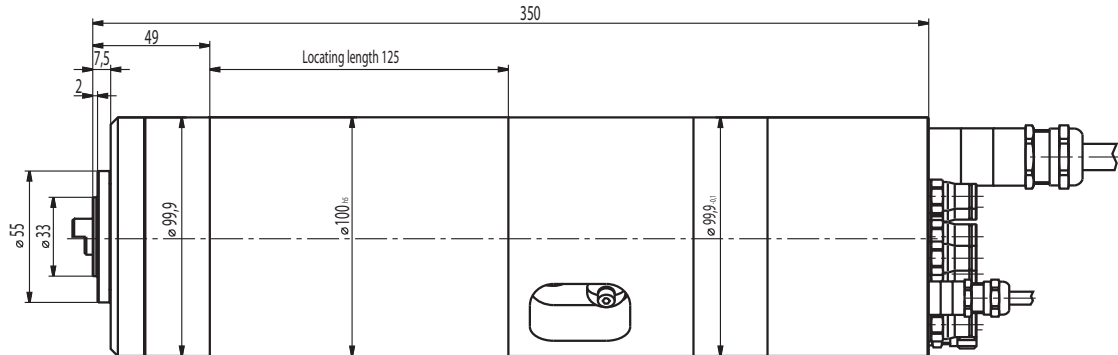

Synchronous motor

Power P (S1)	5 kW at 60,000 rpm
Torque M (S1)	0.8 Nm
Speed n_{max}	60,000 rpm
Drive	open-loop

High precision hybrid ball bearings

Bore diameter	35 mm
Lubrication	Oil/air

Tool interface

Interface	HSK-E 32
Monitoring	"clamped", "unclamped"
Static tool pull-in force	4 kN

Seal

Rigidity

Radial	96 N/ μ m
Axial	35 N/ μ m

Also available with permanent grease lubrication. This lubrication leads to speed reduction.

HCS 120 - 45000/15

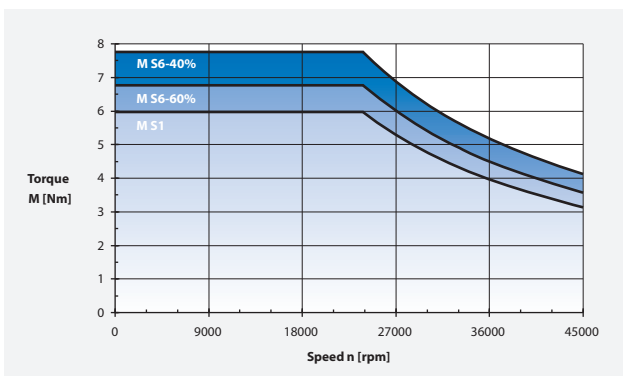
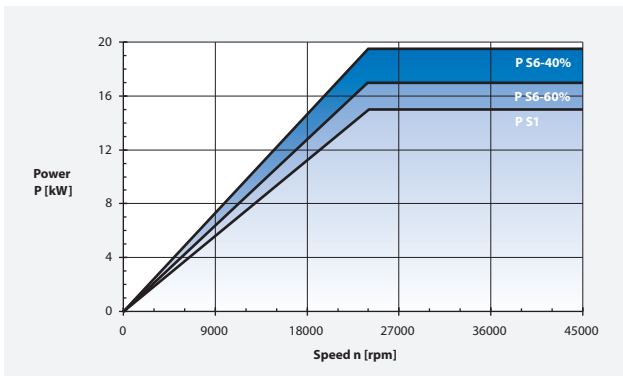
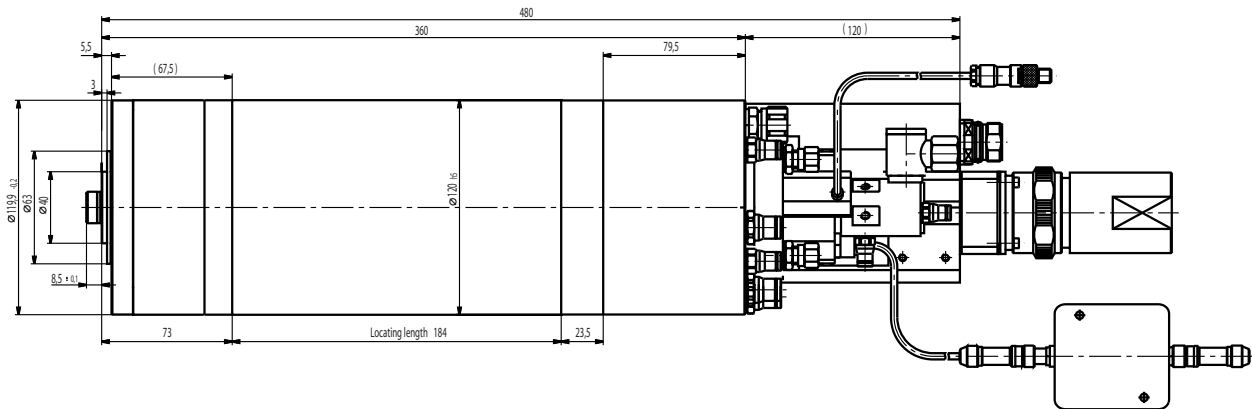

Synchronous motor

Power P (S1)	15 kW at 24,000 rpm
Torque M (S1)	6 Nm
Speed n_{max}	45,000 rpm
Drive	closed-loop

Hybrid ball bearings

Bore diameter	
of front bearings	45 mm
Lubrication	Oil/air

Tool interface

Interface	HSK-E 40
Monitoring	
"clamped", "unclamped",	
"clamped without tool"	Proximity switches
Taper cleaning	Air
Static tool pull-in force	6.8 kN

Seal

Coolant

through shaft	80 bar
---------------------	--------

Shaft movement

Compensating - Axial	Temperature sensor
----------------------------	--------------------

Rigidity

Radial	125 N/ μ m
Axial	91 N/ μ m

Also available with permanent grease lubrication. This lubrication leads to speed reduction.

HCS 120 - 60000/10,5

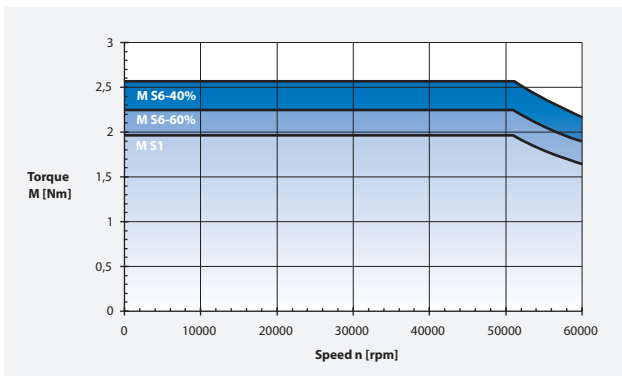
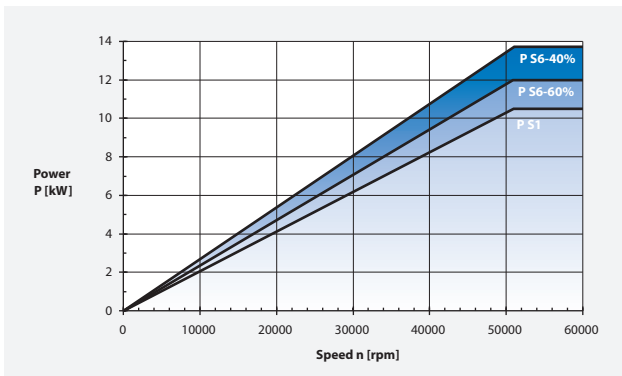
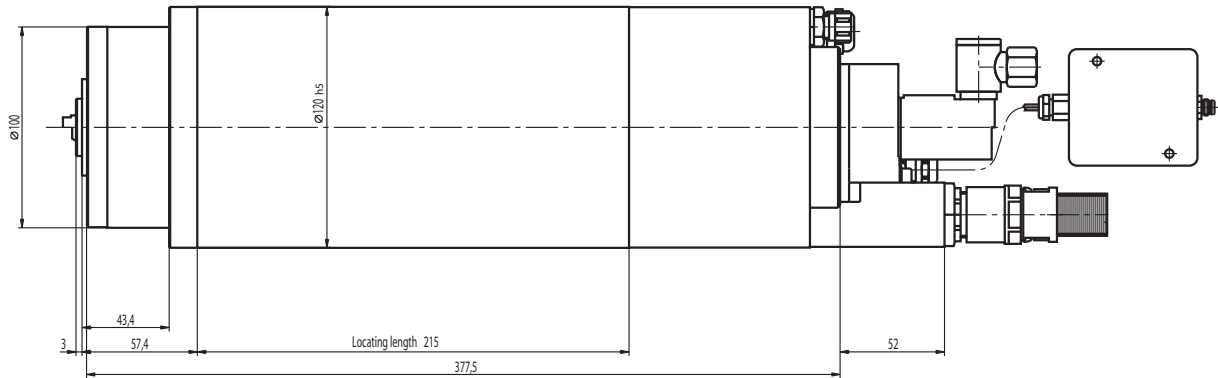

Asynchronous motor

- Power P (S1) 10.5 kW at 51,000 rpm
- Torque M (S1) 2 Nm
- Speed n_{max} 60,000 rpm
- Drive closed-loop

Hybrid ball bearings

- Bore diameter of front bearings 30 mm
- Lubrication Oil/air

Tool interface

- Interface HSK-E 25
- Monitoring "clamped", "unclamped", "clamped without tool" Analog sensor
- Taper cleaning Air
- Static tool pull-in force 2.8 kN

Seal Air purge

Coolant

- through shaft 80 bar

Rigidity

- Radial 110 N/ μ m
- Axial 70 N/ μ m

Also available with permanent grease lubrication. This lubrication leads to speed reduction.

HCS 120 - 75000/10

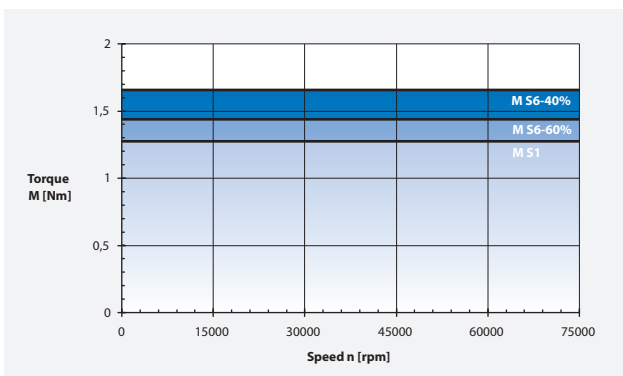
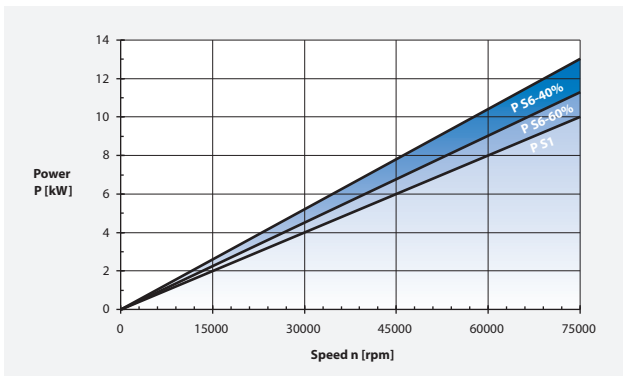
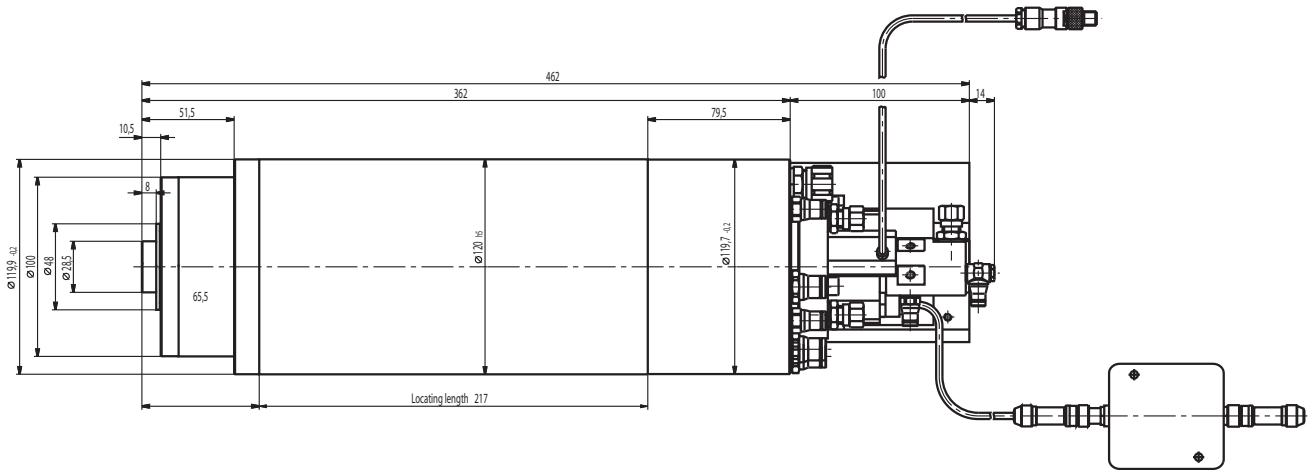

Synchronous motor

Power P (S1)	10 kW at 75,000 rpm
Torque M (S1)	1.3 Nm
Speed n_{max}	75,000 rpm
Drive	closed-loop

Hybrid ball bearings

Bore diameter	
of front bearings	30 mm
Lubrication	Oil/air

Tool interface

Interface	HSK-E 25
Monitoring	
"clamped", "unclamped",	
"clamped without tool"	Analog sensor
Taper cleaning	Air
Static tool pull-in force	2.8 kN

Seal

.....	Air purge
-------	-----------

Coolant

through shaft	80 bar
---------------------	--------

Shaft movement

Compensating - Axial	Temperature sensor
----------------------------	--------------------

Rigidity

Radial	110 N/ μ m
Axial	69 N/ μ m

Also available with permanent grease lubrication. This lubrication leads to speed reduction.

HCS 120 - 90000/4,4

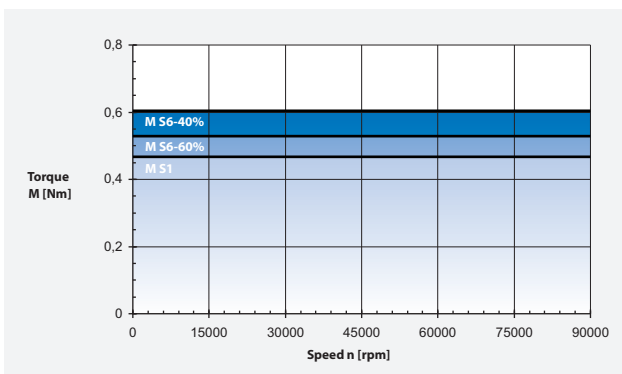
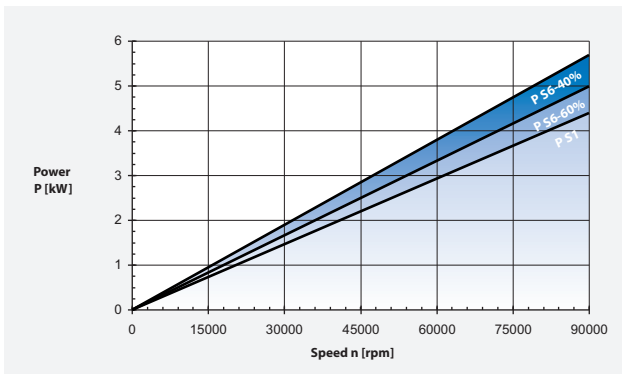
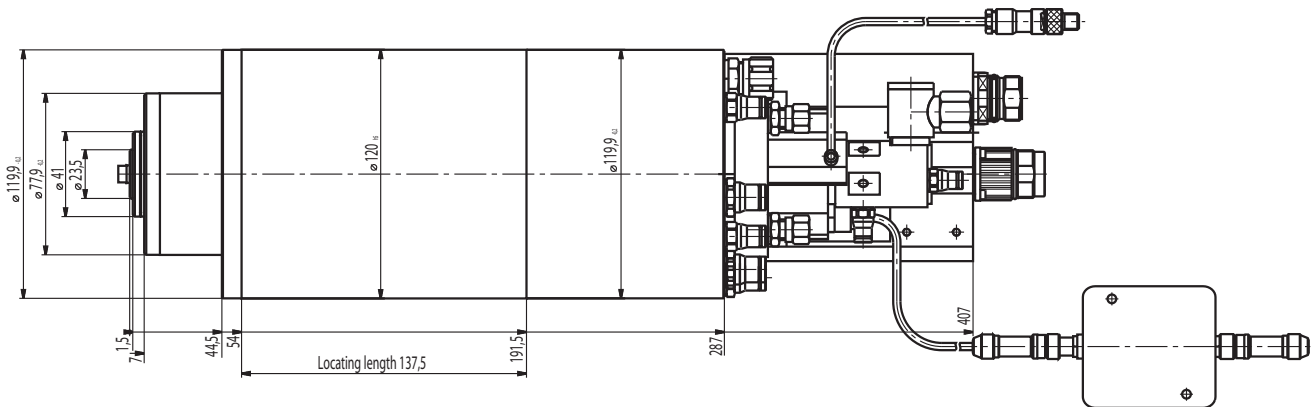

Synchronous motor

Power P (S1)	4.4 kW at 90,000 rpm
Torque M (S1)	0.47 Nm
Speed n_{max}	90,000 rpm
Drive	closed-loop

Hybrid ball bearings

Bore diameter	
of front bearings	25 mm
Lubrication	Oil/air

Tool interface

Interface	HSK-E 20
Monitoring	
"clamped", "unclamped",	
"clamped without tool"	Analog sensor
Taper cleaning	Air
Static tool pull-in force	1.8 kN

Seal

.....	Air purge
-------	-----------

Coolant

through shaft	50 bar
---------------------	--------

Rigidity

Radial	59 N/ μ m
Axial	57 N/ μ m

Also available with permanent grease lubrication. This lubrication leads to speed reduction.

HCS 125 - 42000/15

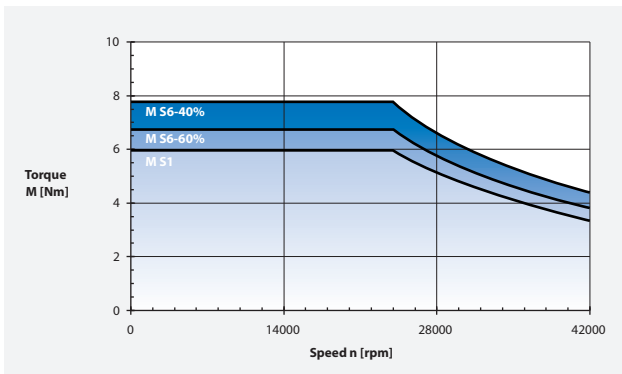
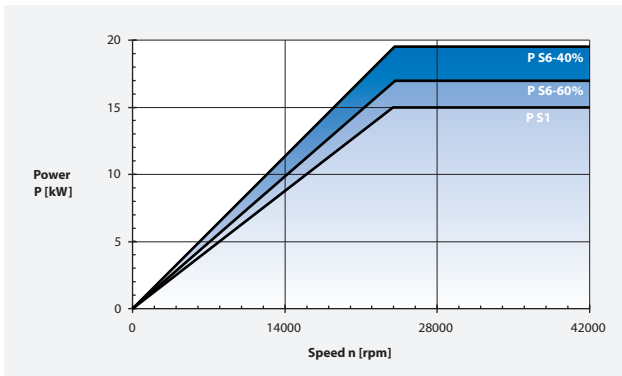
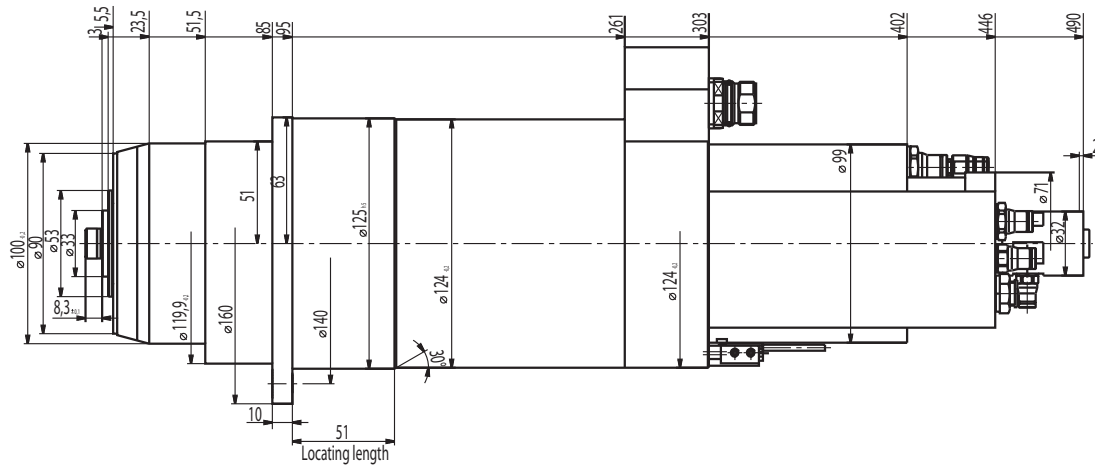

Synchronous motor

Power P (S1)	15 kW at 24,000 rpm
Torque M (S1)	6 Nm
Speed n_{max}	42,000 rpm
Drive	closed-loop

Hybrid ball bearings

Bore diameter	
of front bearings	35 mm
Lubrication	Oil/air

Tool interface

Interface	HSK-E 32
Monitoring	
"clamped", "unclamped",	
"clamped without tool"	Analog sensor
Taper cleaning	Air
Static tool pull-in force	5 kN

Seal

Shaft movement

Measuring - Axial	Displacement sensor
-------------------------	---------------------

Rigidity

Radial	146 N/ μ m
Axial	84 N/ μ m

Also available with permanent grease lubrication. This lubrication leads to speed reduction.

HCS 150 - 42000/30

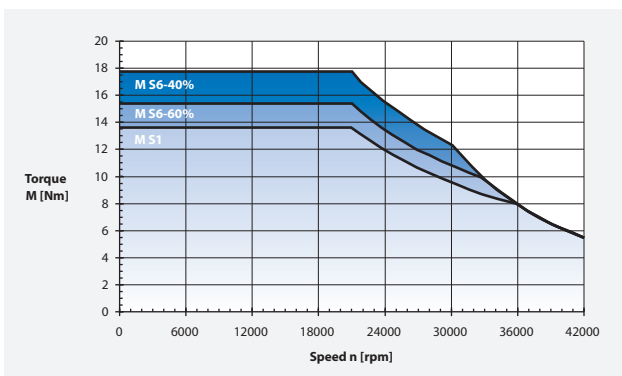
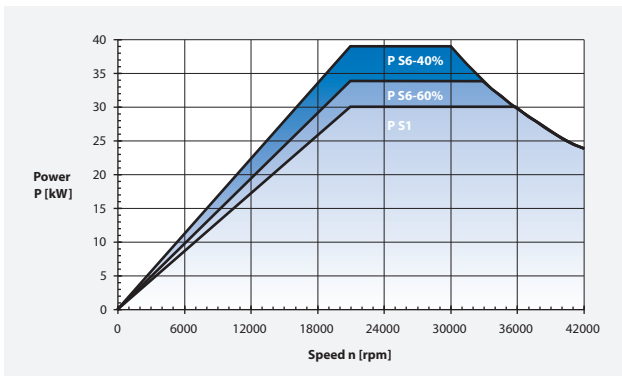
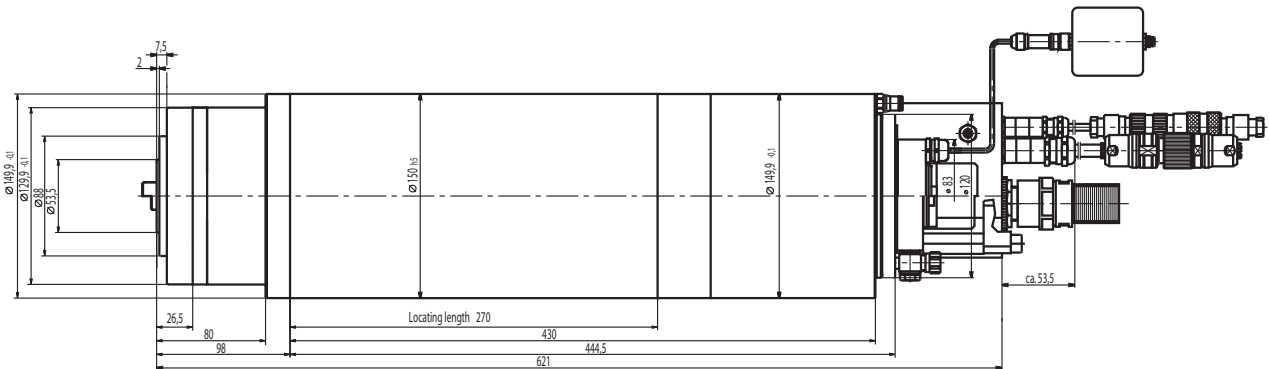

Synchronous motor

Power P (S1)	30 kW at 21,000 rpm
Torque M (S1)	13.7 Nm
Speed n_{max}	42,000 rpm
Drive	closed-loop

Hybrid ball bearings

Bore diameter	
of front bearings	55 mm
Lubrication	Oil/air
Bearing preload	adjustable

Tool interface

Interface	HSK-E 50
Monitoring	
"clamped", "unclamped",	
"clamped without tool"	Analog sensor
Taper cleaning	Air
Static tool pull-in force	7.5 kN

Seal

Shaft movement

Compensating - Axial	Temperature sensor
Measuring - Axial	Displacement sensor
Measuring - Radial	2 Displacement sensors

Rigidity

Radial	162 N/ μ m
Axial	128 N/ μ m

Also available with permanent grease lubrication. This lubrication leads to speed reduction.

HCS 170 - 24000/41

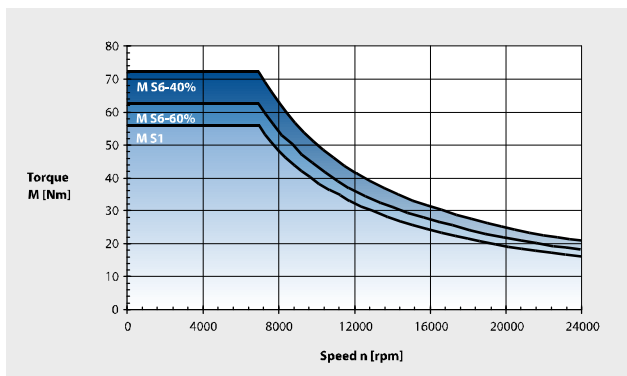
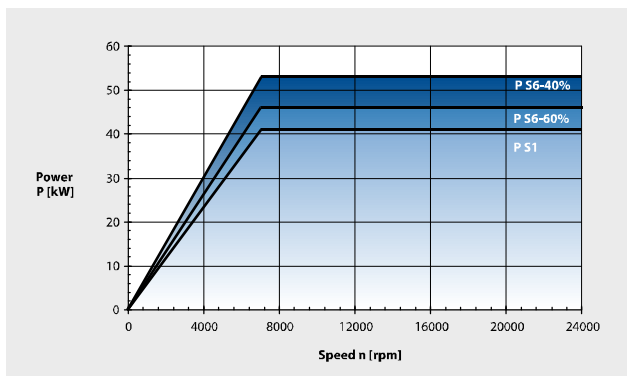
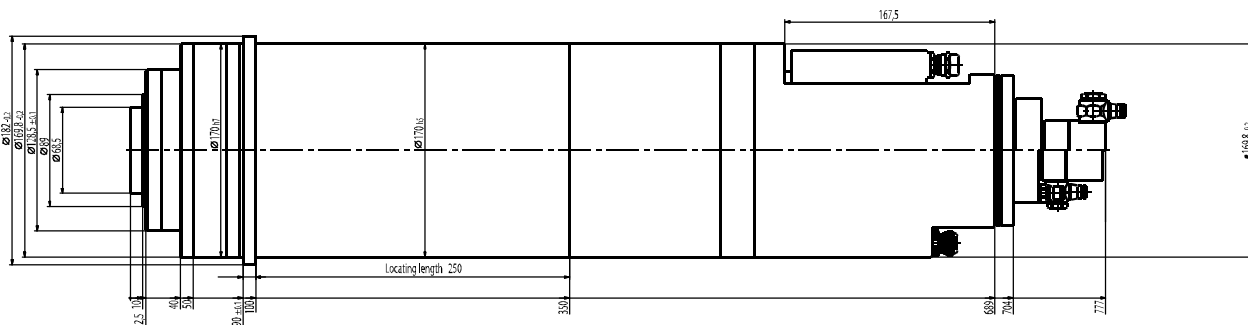

Synchronous motor

Power P (S1)	41 kW at 7,000 rpm
Torque M (S1)	56 Nm
Speed n_{max}	24,000 rpm
Drive	closed-loop

Hybrid ball bearings

Bore diameter	
of front bearings	70 mm
Lubrication	Oil/air

Tool interface

Interface	HSK-A 63
Monitoring	
"clamped", "unclamped",	
"clamped without tool"	Proximity switches
Taper cleaning	Air
Static tool pull-in force	18 kN

Seal

Coolant

through shaft	50 bar
---------------------	--------

Rigidity

Radial	394 N/ μ m
Axial	150 N/ μ m

Also available with permanent grease lubrication. This lubrication leads to speed reduction.

HCS 170 - 30000/40

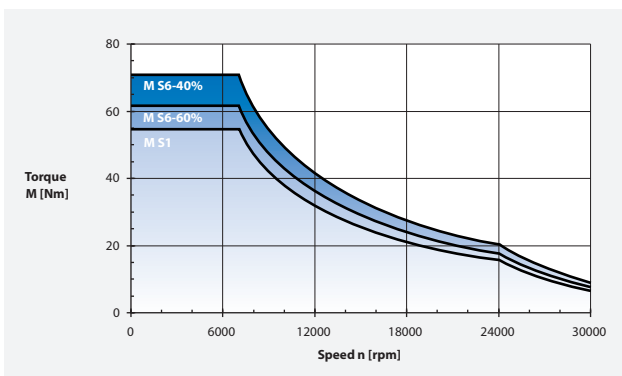
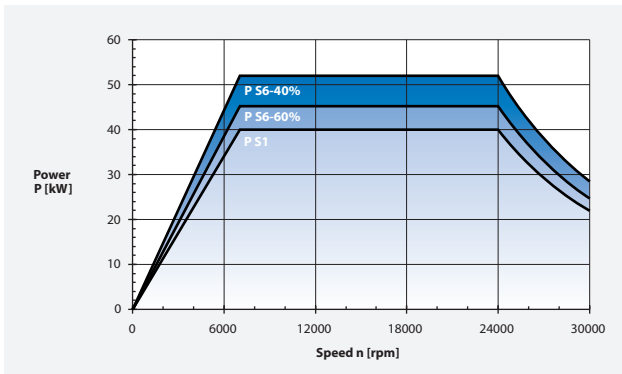
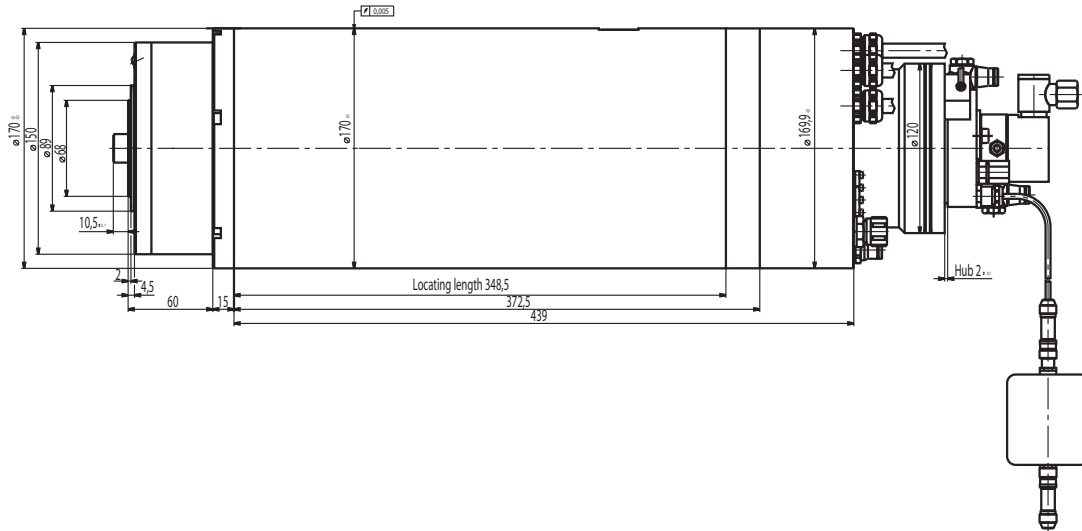

Synchronous motor

Power P (S1)	40 kW at 7,000 rpm
Torque M (S1)	55 Nm
Speed n_{max}	30,000 rpm
Drive	closed-loop

Hybrid ball bearings

Bore diameter of front bearings	70 mm
Lubrication	Oil/air

Tool interface

Interface	HSK-A 63
Monitoring "clamped", "unclamped", "clamped without tool"	Analog sensor
Taper cleaning	Air
Static tool pull-in force	11 kN

Seal

Coolant

through shaft	80 bar
through spindle housing	10 bar

Rigidity

Radial	470 N/ μ m
Axial	135 N/ μ m

Also available with permanent grease lubrication. This lubrication leads to speed reduction.

HCS 170 - 40000/39

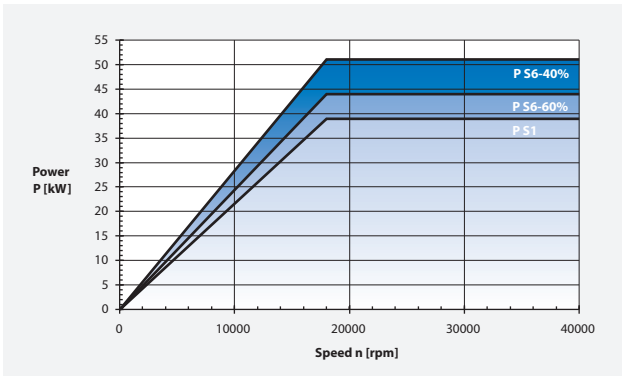
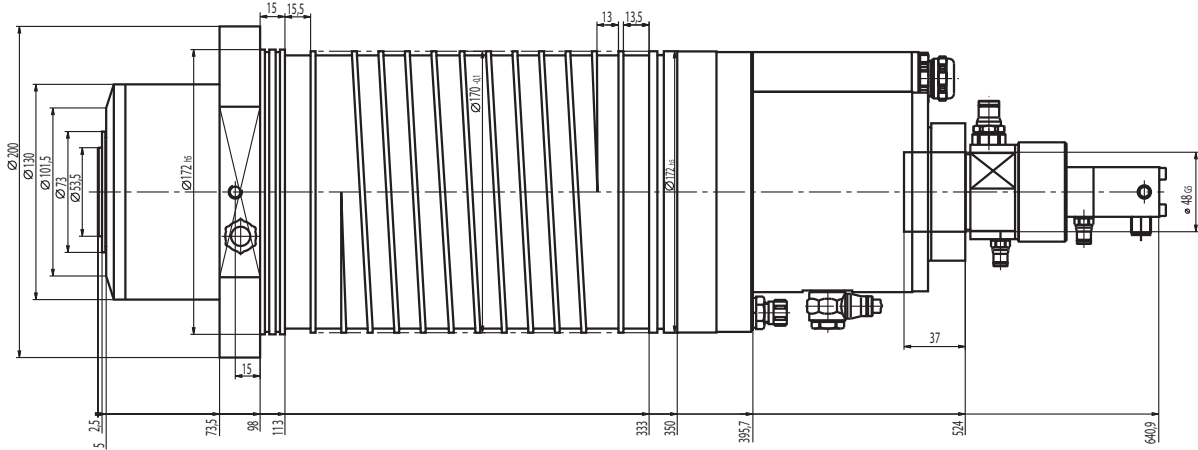

Asynchronous motor

Power P (S1)	39 kW at 18,000 rpm
Torque M (S1)	20.7 Nm
Speed n_{max}	40,000 rpm
Drive	closed-loop

Hybrid ball bearings

Bore diameter	
of front bearings	55 mm
Lubrication	Oil/air

Tool interface

Interface	HSK-E 50
Monitoring	
"clamped", "unclamped"	Proximity switches
Taper cleaning	Air
Static tool pull-in force	10 kN

Seal

.....	Air purge
-------	-----------

Coolant

through shaft

.....	80 bar
-------	--------

Shaft movement

Compensating - Axial	Temperature sensor
Measuring - Axial	Displacement sensor

Rigidity

Radial	307 N/ μ m
Axial	102 N/ μ m

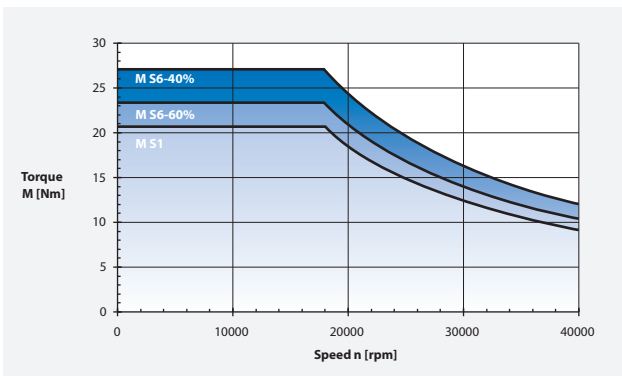

Also available with permanent grease lubrication. This lubrication leads to speed reduction.

HCS 170g - 15000/20

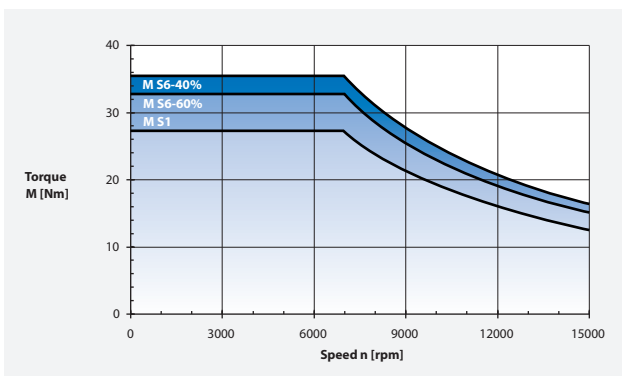
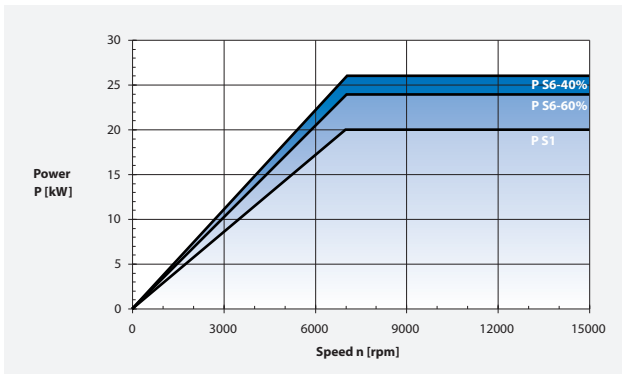
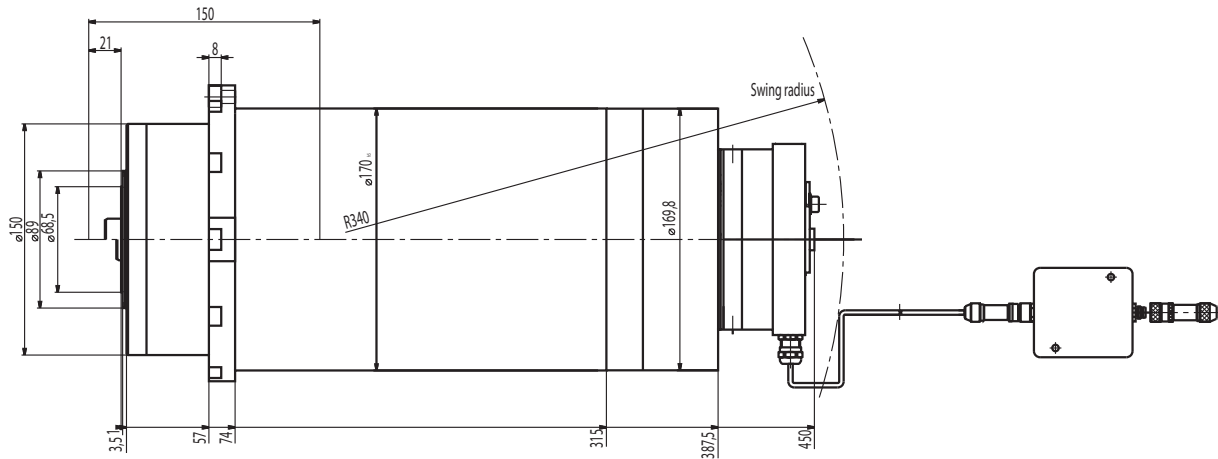

Synchronous motor

Power P (S1)	20 kW at 7,000 rpm
Torque M (S1)	27.3 Nm
Speed n_{max}	15,000 rpm
Drive	closed-loop

Hybrid ball bearings

Bore diameter	
of front bearings	70 mm
Lubrication	Grease

Tool interface

Interface	HSK-A 63
Monitoring	
"clamped", "unclamped",	
"clamped without tool"	Analog sensor
Taper cleaning	Air
Static tool pull-in force	18 kN

Seal

Rigidity

Radial	500 N/ μ m
Axial	170 N/ μ m

Also available for oil/air lubrication.
This lubrication possibly leads to increase of speed.

HCS 200 - 42000/10

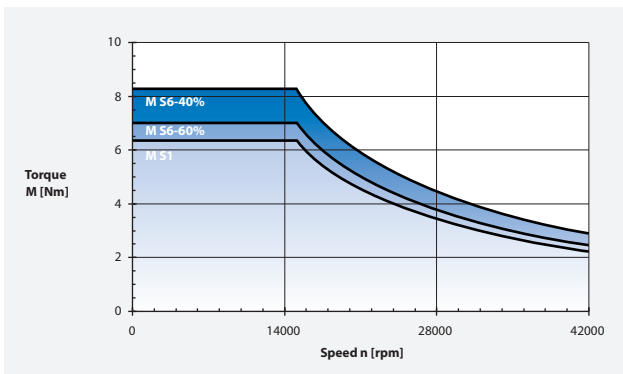
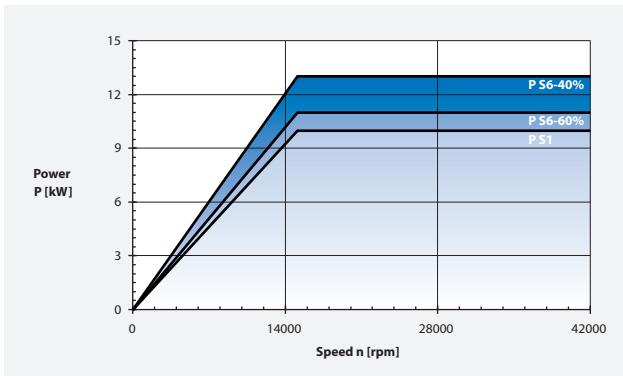
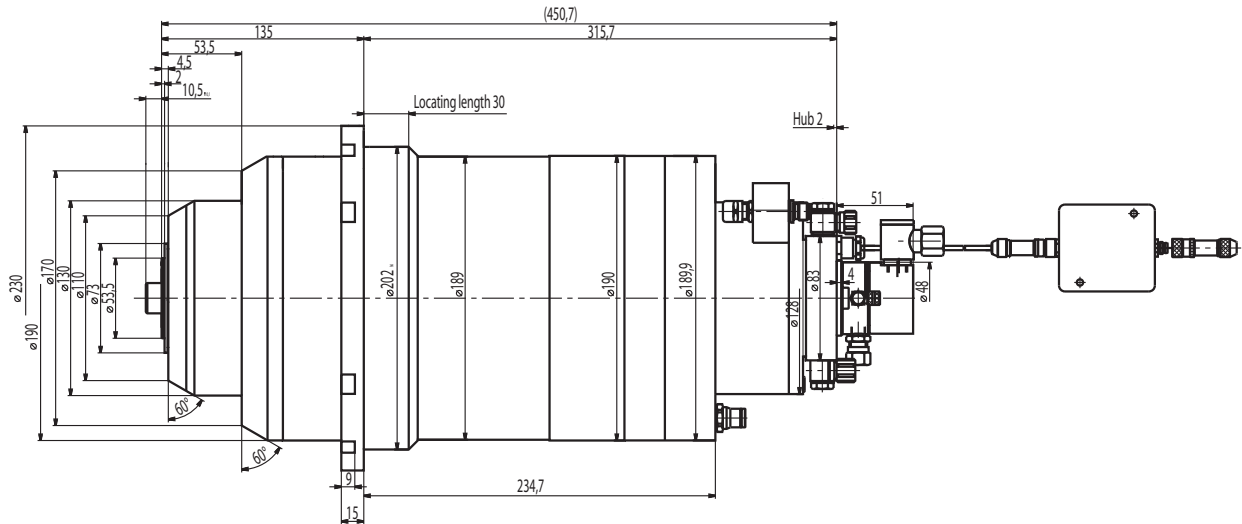

Asynchronous motor

Power P (S1)	10 kW at 15,000 rpm
Torque M (S1)	6.4 Nm
Speed n_{max}	42,000 rpm
Drive	closed-loop

Hybrid ball bearings

Bore diameter	
of front bearings	55 mm
Lubrication	Oil/air

Tool interface

Interface	HSK-A 50 / HSK-E 50
Monitoring	
"clamped", "unclamped",	
"clamped without tool"	Analog sensor
Taper cleaning	Air
Static tool pull-in force	10 kN

Seal

.....	Air purge
-------	-----------

Coolant

through shaft

.....	40 bar
-------	--------

Shaft movement

Compensating - Axial

.....	Temperature sensor
-------	--------------------

Rigidity

Radial	270 N/ μ m
Axial	140 N/ μ m

Option

- Acceleration sensor
- Shaft movement sensor

Also available with permanent grease lubrication. This lubrication leads to speed reduction.

HCS 230 - 12000/30

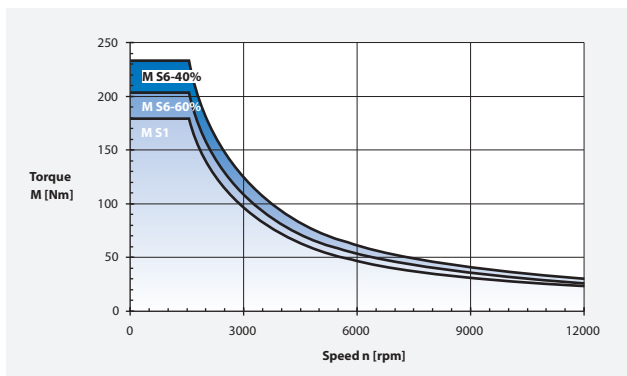
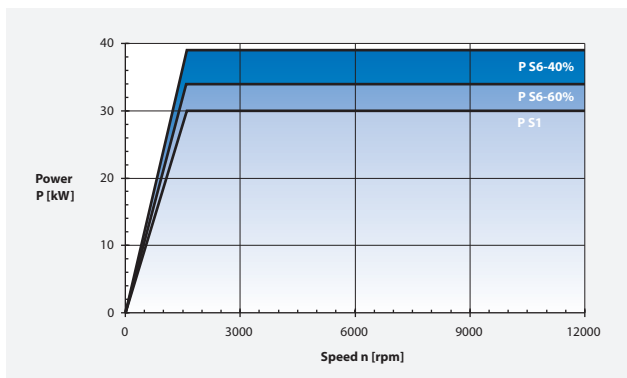
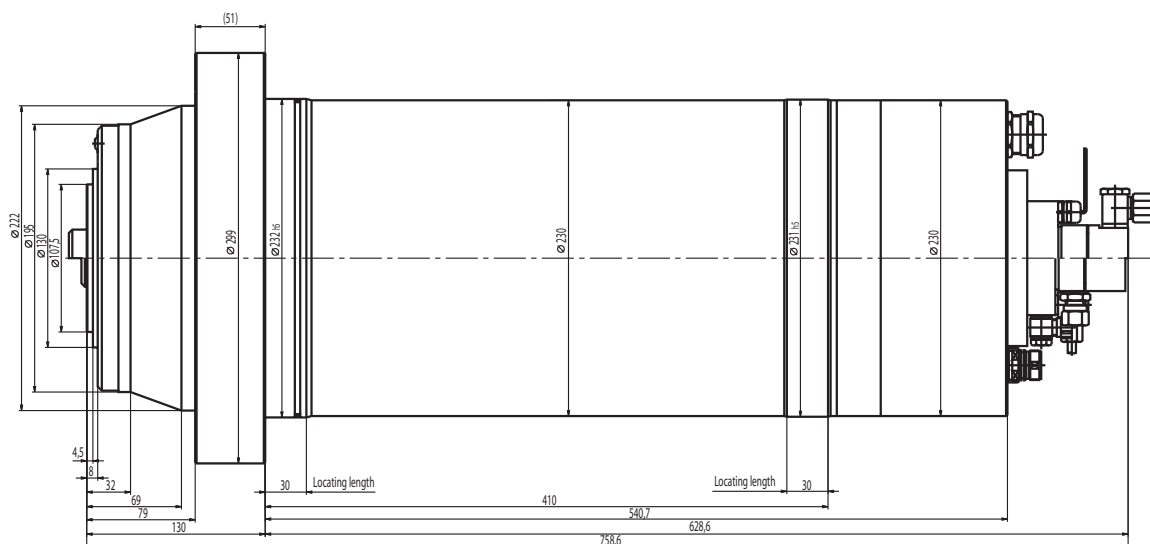

Synchronous motor

Power P (S1)	30 kW at 1,600 rpm
Torque M (S1)	179.3 Nm
Speed n_{max}	12,000 rpm
Drive	closed-loop

Hybrid ball bearings

Bore diameter	
of front bearings	110 mm
Lubrication	Oil/air

Tool interface

Interface	HSK-A 100
Monitoring	
"clamped", "unclamped",	
"clamped without tool"	Analog sensor
Taper cleaning	Air
Static tool pull-in force	45 kN

Seal

Coolant

through shaft	50 bar
through spindle housing	3 bar

Rigidity

Radial	800 N/ μ m
Axial	320 N/ μ m

Also available with permanent grease lubrication. This lubrication leads to speed reduction.

HCS 230 - 24000/18

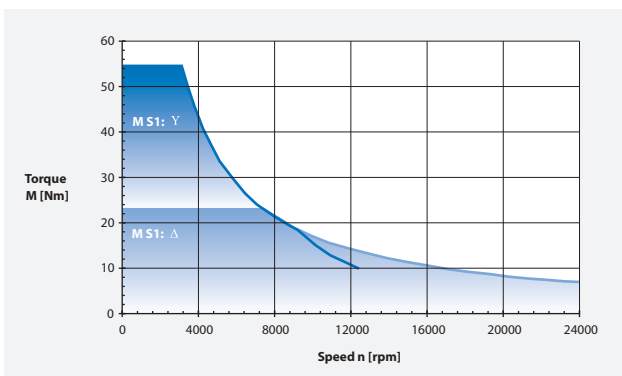
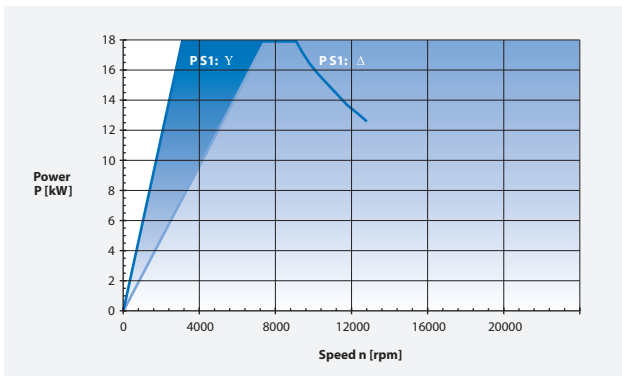
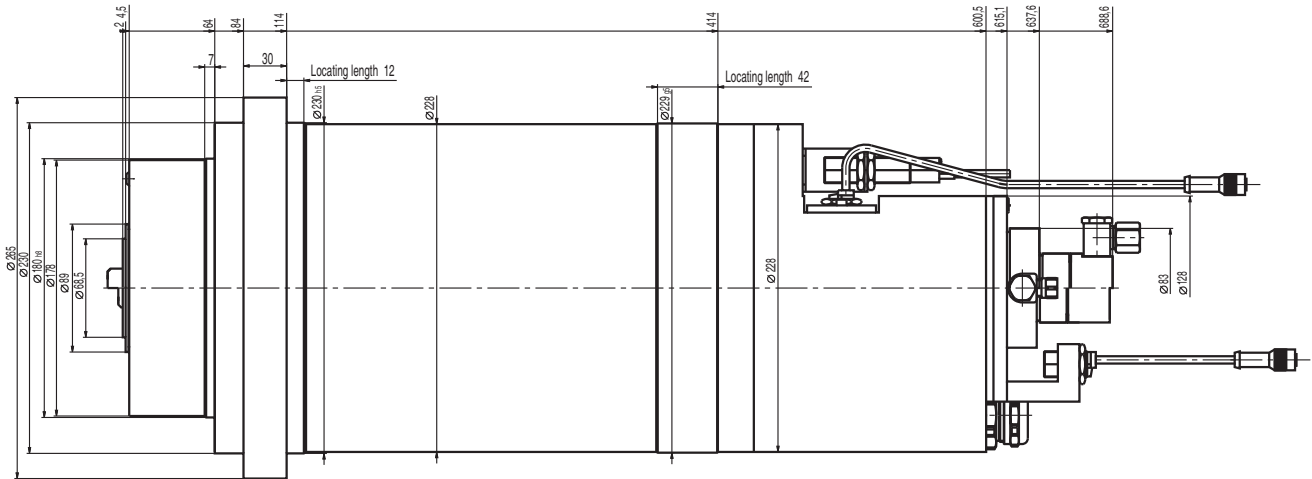

Asynchronous motor

Star-Delta switching

Power P (S1) 18 kW at 3,150 rpm

Torque M (S1) 57 Nm

Speed n_{max} 24,000 rpm

Drive closed-loop

Hybrid ball bearings

Bore diameter

of front bearings 70 mm

Lubrication Oil/air

Bearing preload adjustable

Tool interface

Interface HSK-A 63

Monitoring

"clamped", "unclamped",

"clamped without tool" Proximity switches
or Analog sensor

Taper cleaning Air

Static tool pull-in force 18 kN

Seal Air purge

Coolant

through spindle housing 3 bar

Shaft movement

Compensating - Axial Temperature sensor

Rigidity

Radial 393 N/ μ m

Axial 130 N/ μ m

Also available with permanent grease lubrication.
This lubrication leads to speed reduction.

HCS 230 - 24000/120

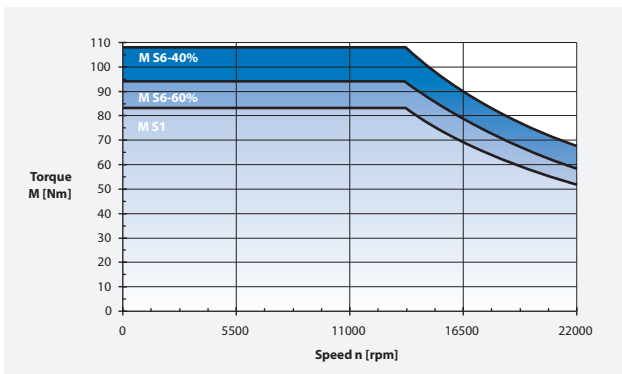
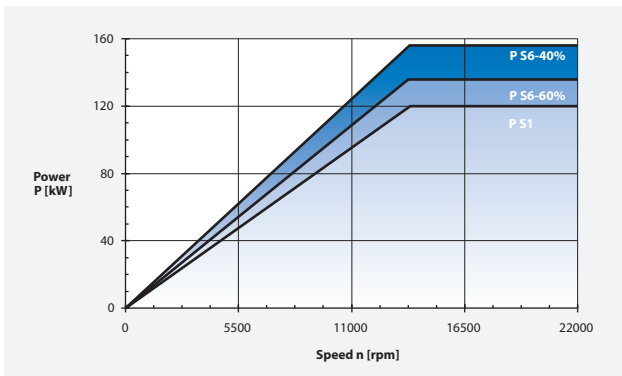
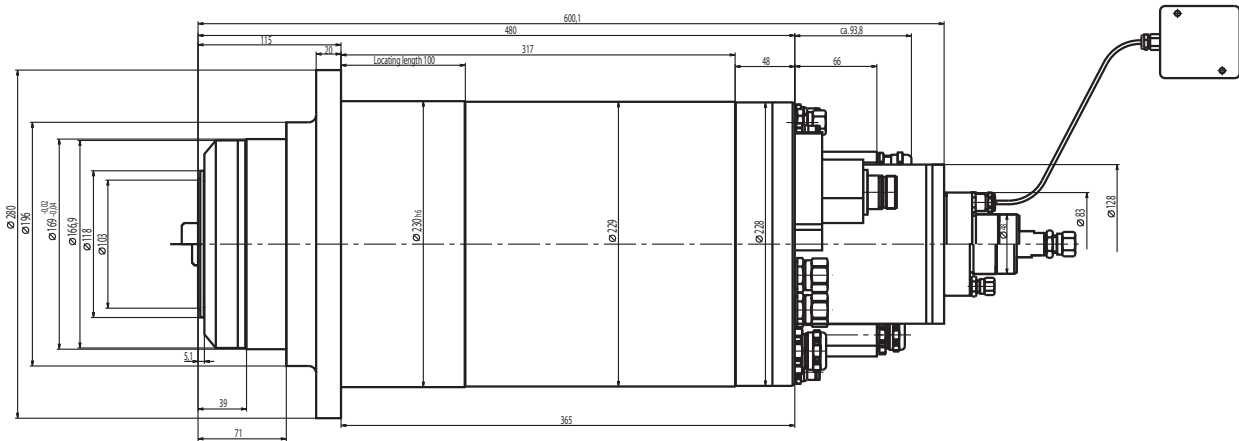

Synchronous motor

Power P (S1).....	120 kW at 13,800 rpm
Torque M (S1).....	83 Nm
Speed n_{max}	24,000 rpm
Drive.....	closed-loop

Hybrid ball bearings

Bore diameter	
of front bearings.....	90 mm
Lubrication.....	Oil/air

Tool interface

Interface.....	HSK-A 80
Monitoring	
"clamped", "unclamped",	
"clamped without tool".....	Proximity switches
Taper cleaning.....	Air
Static tool pull-in force.....	32 kN

Seal..... Air purge

Coolant

through shaft..... 50 bar

Shaft movement

Compensating - Axial.....	Temperature sensor
Measuring - Axial.....	Displacement sensor
Measuring - Radial.....	2 Displacement sensors

Vibration recognition..... Sensor

Rigidity

Radial.....	496 N/ μ m
Axial.....	160 N/ μ m

Also available with permanent grease lubrication. This lubrication leads to speed reduction.

HCS 230 - 30000/120

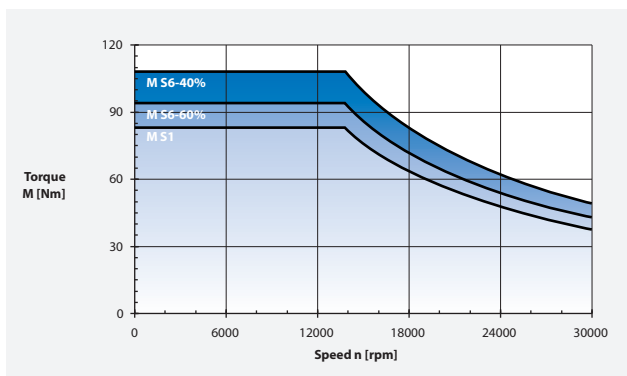
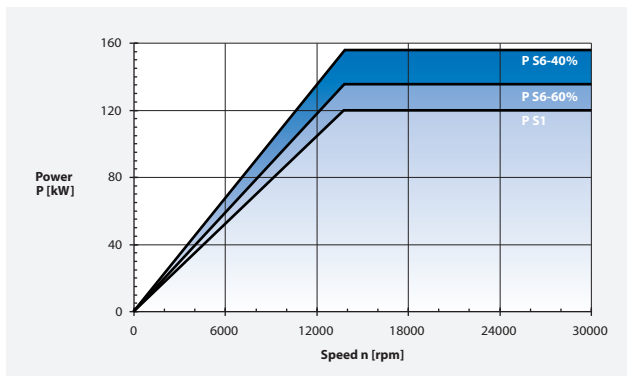
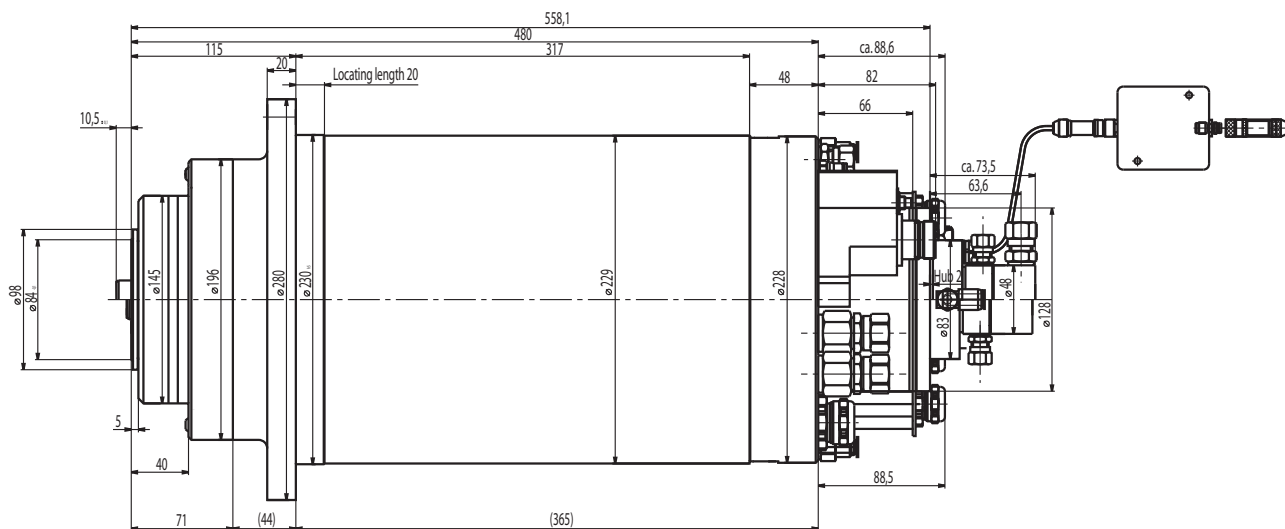

Synchronous motor

Power P (S1)	120 kW at 13,800 rpm
Torque M (S1)	83 Nm
Speed n_{max}	30,000 rpm
Drive	closed-loop

Hybrid ball bearings

Bore diameter	
of front bearings	70 mm
Lubrication	Oil/air

Tool interface

Interface	HSK-A 63 / -F 80
Monitoring	
"clamped", "unclamped",	
"clamped without tool"	Analog sensor
Taper cleaning	Air
Static tool pull-in force	20 kN

Seal

Coolant

through shaft	50 bar
through spindle housing	5 bar

Shaft movement

Compensating - Axial	Temperature sensor
----------------------------	--------------------

Rigidity

Radial	380 N/ μ m
Axial	145 N/ μ m

Option

Vibration sensor	
Shaft movement sensor	

Also available with permanent grease lubrication. This lubrication leads to speed reduction.

HCS 230 - 40000/22

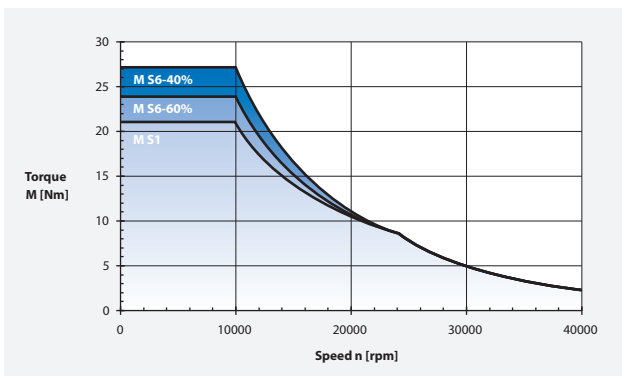
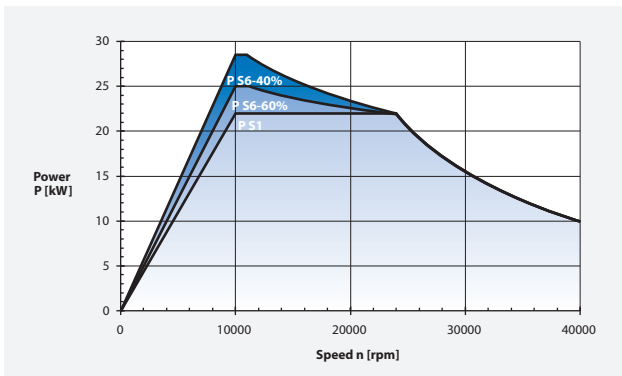
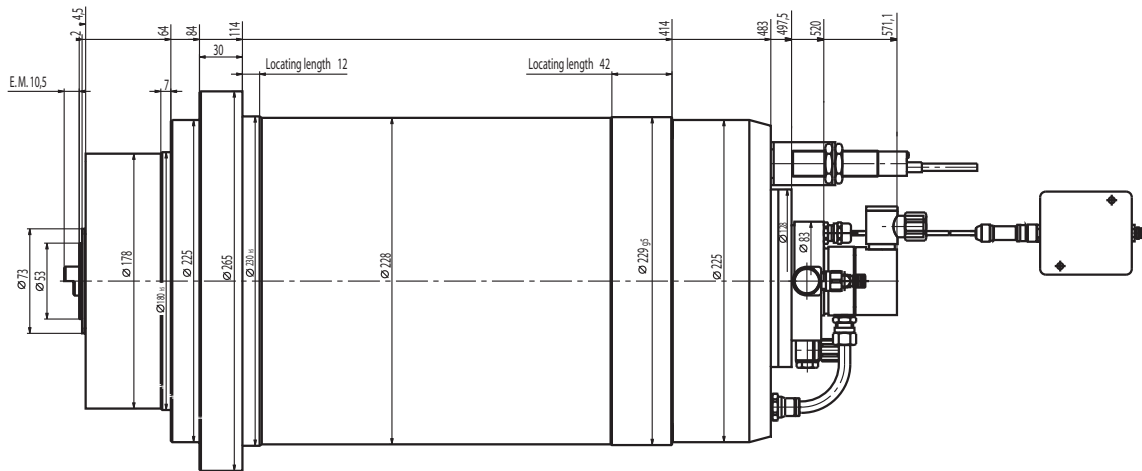

Asynchronous motor

Power P (S1)	22 kW at 10,000 rpm
Torque M (S1)	21 Nm
Speed n_{max}	40,000 rpm
Drive	closed-loop

Hybrid ball bearings

Bore diameter	
of front bearings	55 mm
Lubrication	Oil/air

Tool interface

Interface	HSK-E 50
Monitoring	
"clamped", "unclamped",	
"clamped without tool"	Analog sensor
Taper cleaning	Air
Static tool pull-in force	10 kN

Seal

Shaft movement

Compensating - Axial	Temperature sensor
----------------------------	--------------------

Rigidity

Radial	260 N/ μ m
Axial	130 N/ μ m

Also available with permanent grease lubrication. This lubrication leads to speed reduction.

HCS 230g - 10000/24

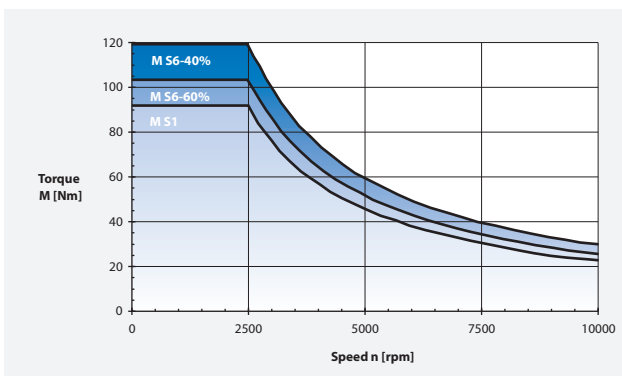
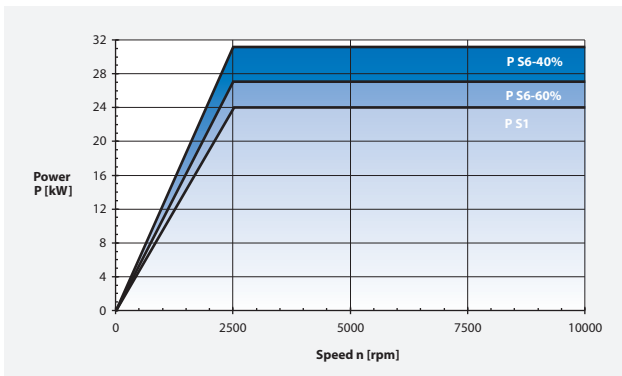
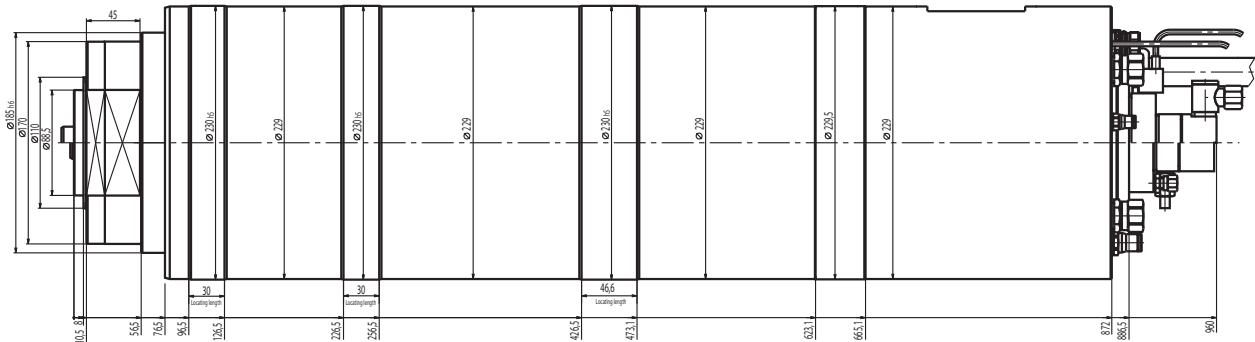

Asynchronous motor

Power P (S1)	24 kW at 2,500 rpm
Torque M (S1)	91.7 Nm
Speed n_{max}	10,000 rpm
Drive	closed-loop

Hybrid ball bearings

Bore diameter	
of front bearings	90 mm
Lubrication	Grease

Tool interface

Interface	HSK-A 63
Monitoring	
"clamped", "unclamped",	
"clamped without tool"	Analog sensor
Taper cleaning	Air
Static tool pull-in force	18 kN

Seal

Coolant

through shaft	50 bar
---------------------	--------

Rigidity

Radial	600 N/ μ m
Axial	430 N/ μ m

Also available for oil/air lubrication.
This lubrication possibly leads to increase of speed.

HCS 230g - 16000/24

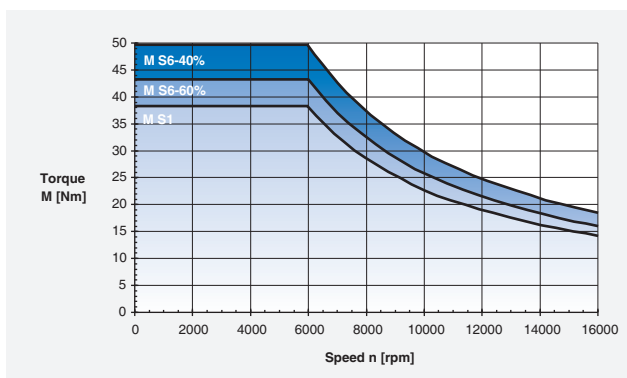
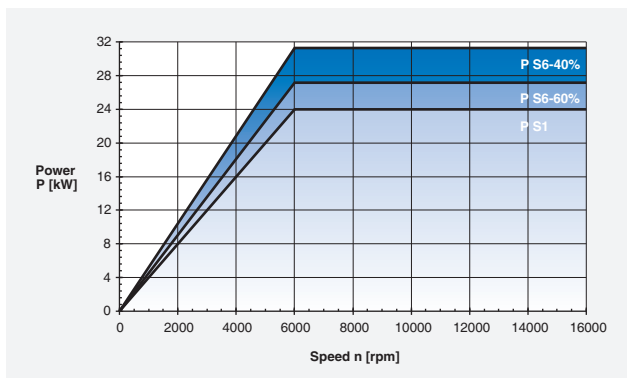
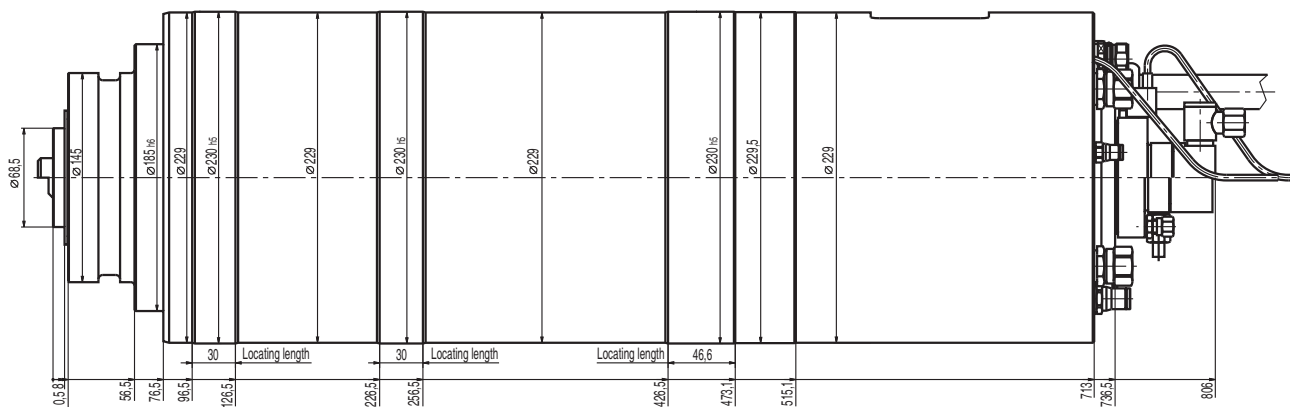

Asynchronous motor

Power P (S1)	24 kW at 6,000 rpm
Torque M (S1)	38.2 Nm
Speed n_{max}	16,000 rpm
Drive	closed-loop

Hybrid ball bearings

Bore diameter	
of front bearings	70 mm
Lubrication	Grease

Tool interface

Interface	HSK-A 63
Monitoring	
"clamped", "unclamped",	
"clamped without tool"	Analog sensor
Taper cleaning	Air
Static tool pull-in force	18 kN

Seal

Coolant

through shaft	50 bar
---------------------	--------

Rigidity

Radial	454 N/ μ m
Axial	317 N/ μ m

Also available for oil/air lubrication.
This lubrication possibly leads to increase of speed.

HCS 230g - 16000/40

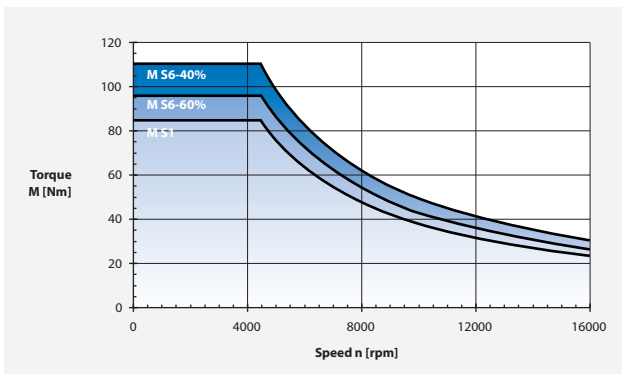
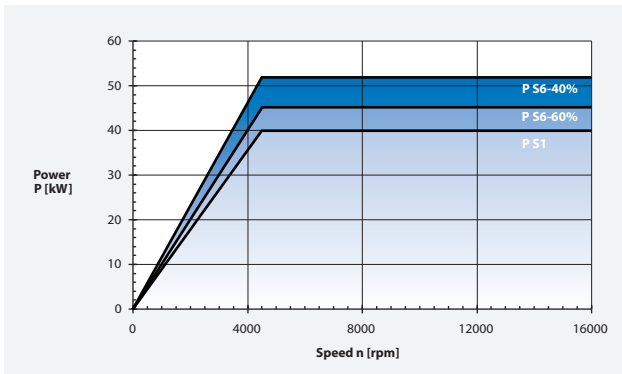
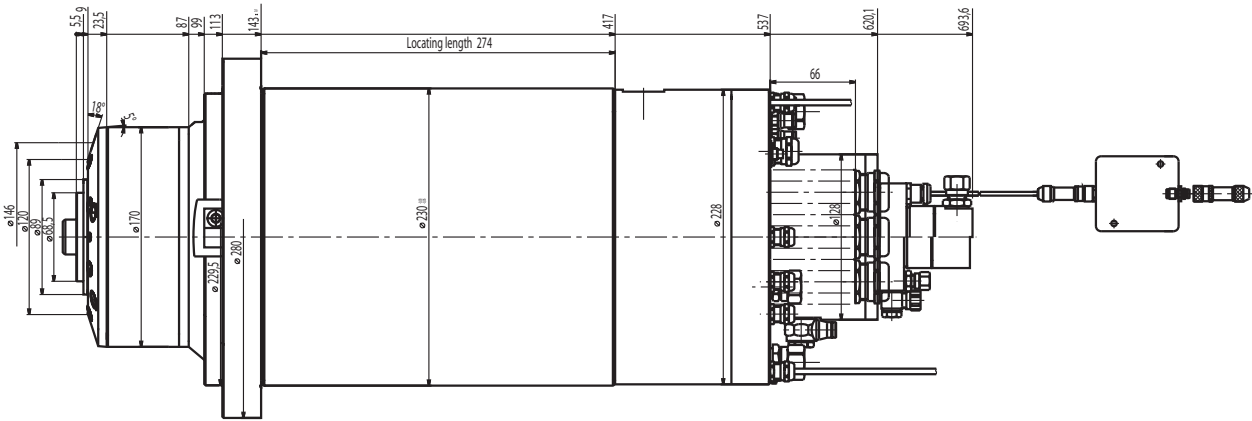

Asynchronous motor

Power P (S1)	40 kW at 4,500 rpm
Torque M (S1)	85 Nm
Speed n_{max}	16,000 rpm
Drive	closed-loop

Hybrid ball bearings

Bore diameter	
of front bearings	70 mm
Lubrication	Oil/air

Tool interface

Interface	HSK-A 63
Monitoring	
"clamped", "unclamped",	
"clamped without tool"	Analog sensor
Taper cleaning	Air
Static tool pull-in force	20 kN

Seal

.....	Air purge
-------	-----------

Coolant

through shaft	80 bar
through spindle housing	10 bar

Shaft movement

Compensating - Axial	Temperature sensor
----------------------------	--------------------

Rigidity

Radial	647 N/ μ m
Axial	282 N/ μ m

Option

Shaft displacement sensor	
Vibration sensor	

Also available for oil/air lubrication.
This lubrication possibly leads to increase of speed.

HCS 260 - 12000/40

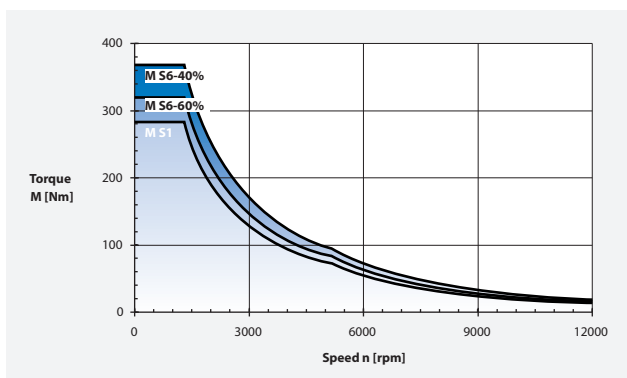
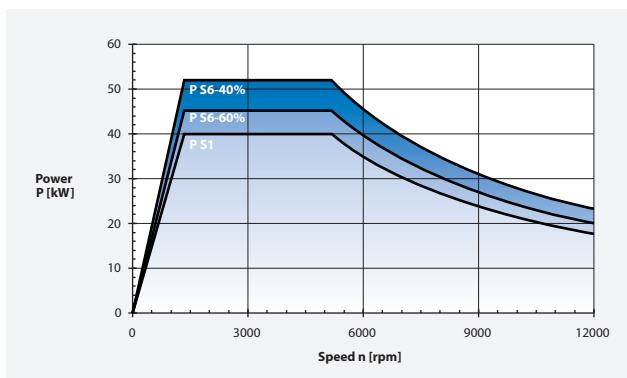
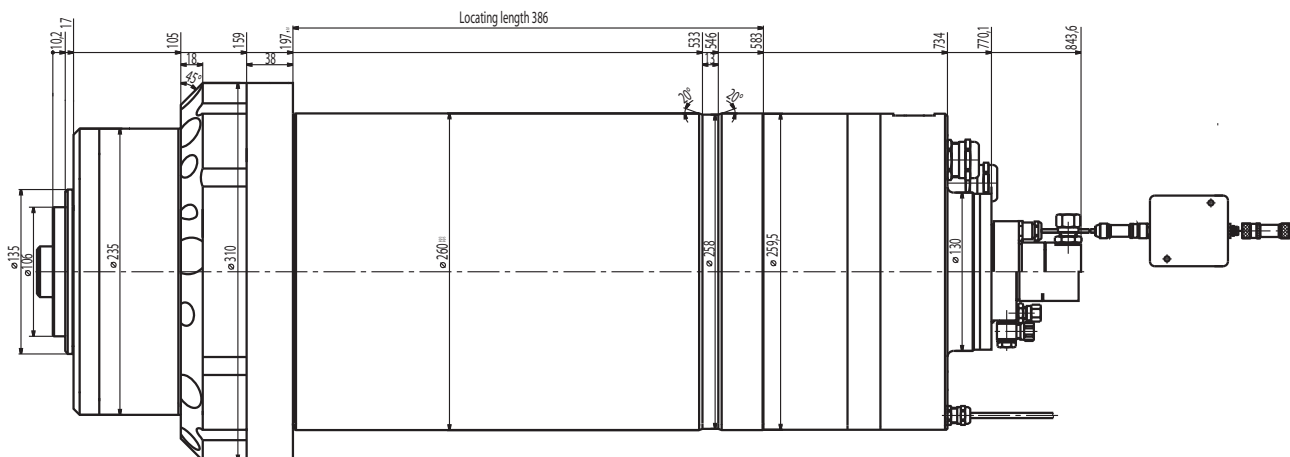

Asynchronous motor

- Power P (S1) 40 kW at 1,350 rpm
- Torque M (S1) 298 Nm
- Speed n_{max} 12,000 rpm
- Drive closed-loop

Hybrid ball bearings

- Bore diameter of front bearings 110 mm
- Lubrication Oil/air

Tool interface

- Interface HSK-A 100
- Monitoring "clamped", "unclamped", "clamped without tool" Analog sensor
- Taper cleaning Air
- Static tool pull-in force 45 kN

Seal Air purge

Coolant

- through shaft 80 bar
- through spindle housing

Shaft movement

- Compensating - Axial Temperature sensor

Rigidity

- Radial 640 N/ μ m
- Axial 500 N/ μ m

Option

- Shaft displacement sensor
- Vibration sensor

Also available with permanent grease lubrication. This lubrication leads to speed reduction.

HCS 270g - 10000/94

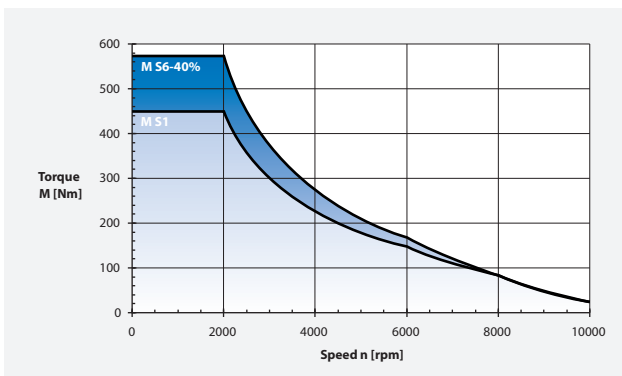
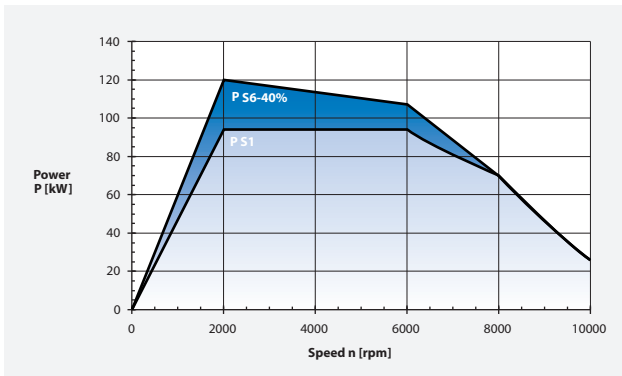
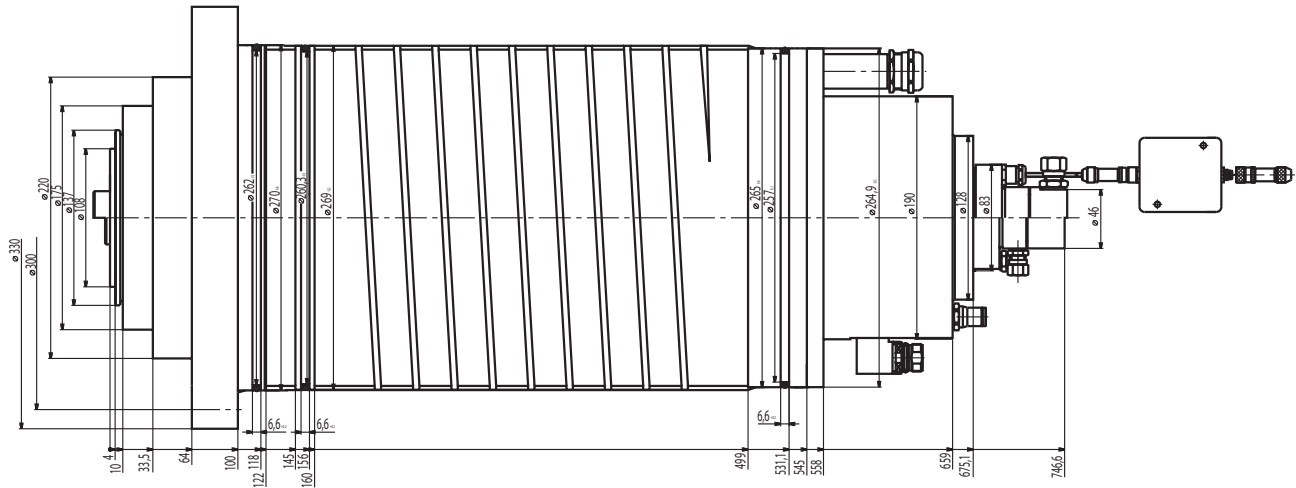

Synchronous motor

Power P (S1)	94 kW at 2,000 rpm
Torque M (S1)	450 Nm
Speed n_{max}	10,000 rpm
Drive	closed-loop

Hybrid ball bearings

Bore diameter	
of front bearings	110 mm
Lubrication	Oil/air

Tool interface

Interface	HSK-A 100 / SK 50
Monitoring	
"clamped", "unclamped",	
"clamped without tool"	Analog sensor
Taper cleaning	Air
Static tool pull-in force	45 kN

Seal

Coolant

through shaft

Shaft movement

Compensating - Axial

Rigidity

Radial	920 N/ μ m
Axial	610 N/ μ m

Also available for oil/air lubrication.
This lubrication possibly leads to increase of speed.

HCS 280 - 18000/60

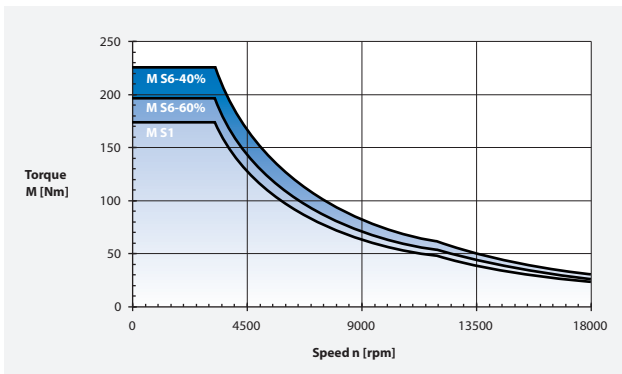
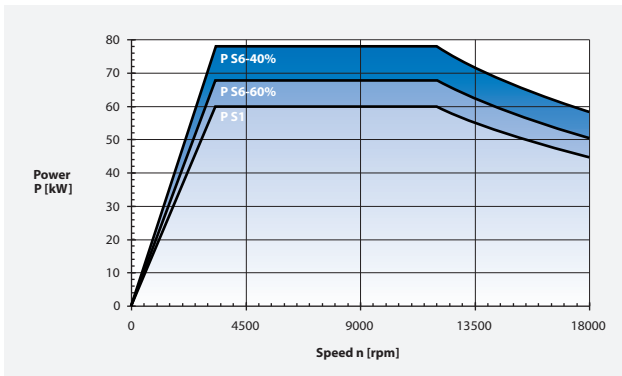
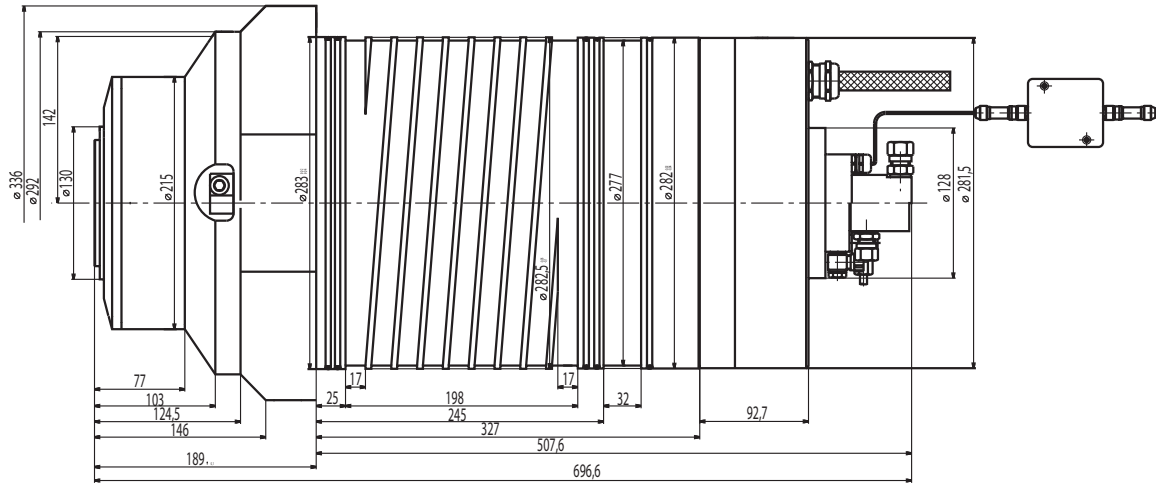

Asynchronous motor

Power P (S1)	60 kW at 3,300 rpm
Torque M (S1)	174 Nm
Speed n_{max}	18,000 rpm
Drive	closed-loop

Hybrid ball bearings

Bore diameter	
of front bearings	110 mm
Lubrication	Oil/air

Tool interface

Interface	HSK-A 100
Monitoring	
"clamped", "unclamped",	
"clamped without tool"	Analog sensor
Taper cleaning	Air
Static tool pull-in force	45 kN

Seal

Coolant

through shaft	80 bar
through spindle housing	10 bar

Shaft movement

Compensating - Axial	Temperature sensor
----------------------------	--------------------

Rigidity

Radial	890 N/ μ m
Axial	310 N/ μ m

Option

Shaft displacement sensor	
Vibration sensor	

Also available with permanent grease lubrication. This lubrication leads to speed reduction.

HCS 285 - 12000/40

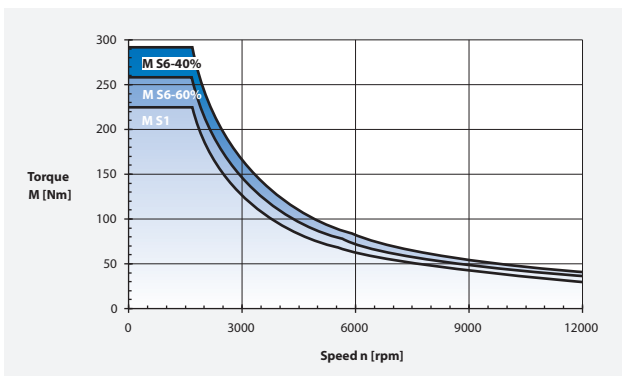
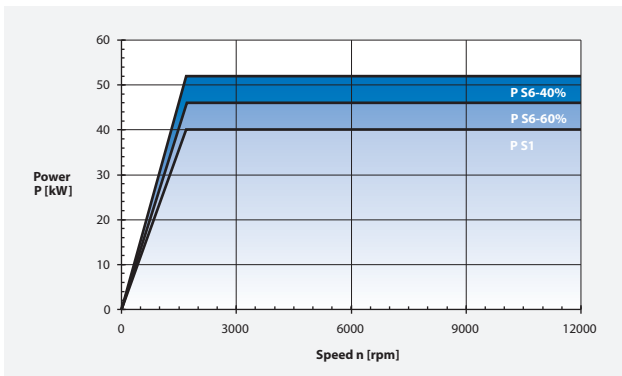
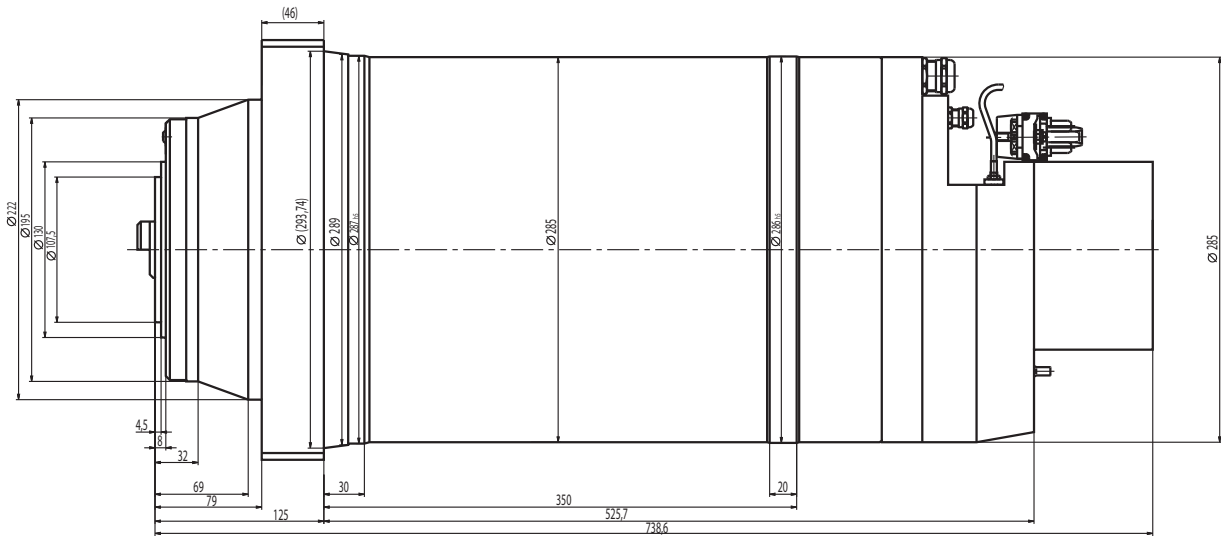

Asynchronous motor

Power P (S1)	40 kW at 1,680 rpm
Torque M (S1)	227.5 Nm
Speed n_{max}	12,000 rpm
Drive	closed-loop

Hybrid ball bearings

Bore diameter	
of front bearings	110 mm
Lubrication	Oil/air

Tool interface

Interface	HSK-A 100
Monitoring	
"clamped", "unclamped",	
"clamped without tool"	Analog sensor
Taper cleaning	Air
Static tool pull-in force	45 kN

Seal

Coolant

through shaft	80 bar
through spindle housing	3 bar

Shaft movement

Compensating - Axial	Temperature sensor
----------------------------	--------------------

Rigidity

Radial	760 N/ μ m
Axial	350 N/ μ m

Also available with permanent grease lubrication. This lubrication leads to speed reduction.

HCS 285g - 4000/24

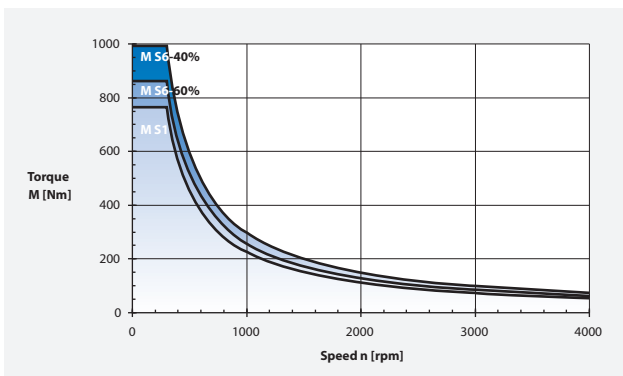
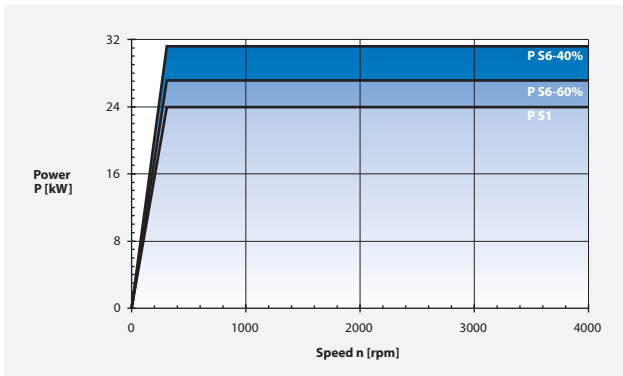
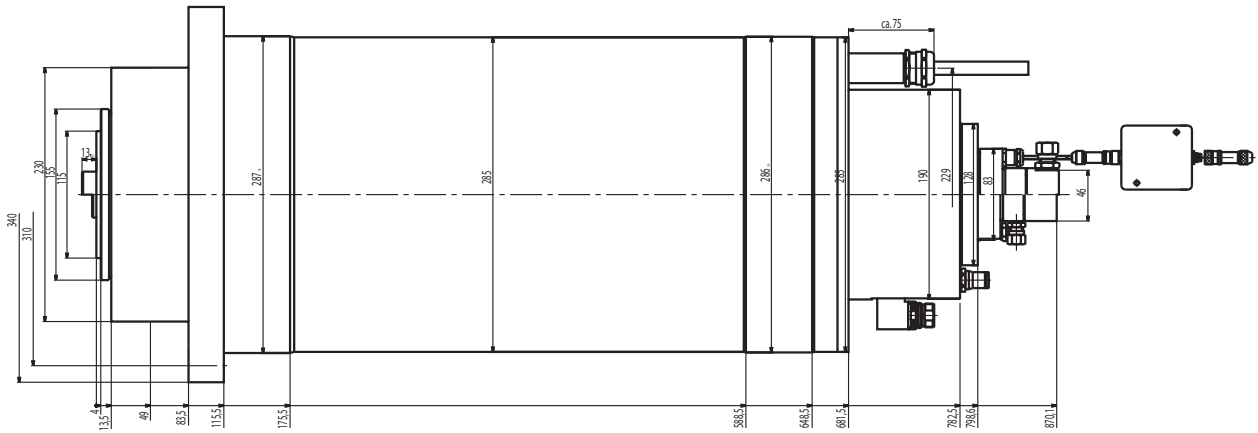

Synchronous motor

Power P (S1)	24 kW at 300 rpm
Torque M (S1)	750 Nm
Speed n_{max}	4,000 rpm
Drive	closed-loop

Hybrid ball bearings

Bore diameter	
of front bearings	110 mm
Lubrication	Grease

Tool interface

Interface	HSK-A 100
Monitoring	
"clamped", "unclamped",	
"clamped without tool"	Analog sensor
Taper cleaning	Air
Static tool pull-in force	45 kN

Seal

Coolant

through shaft	80 bar
through spindle housing	5 bar

sensor

Rigidity

Radial	1,000 N/ μ m
Axial	370 N/ μ m

Also available for oil/air lubrication.
This lubrication possibly leads to increase of speed.

HCS 300 - 12000/30

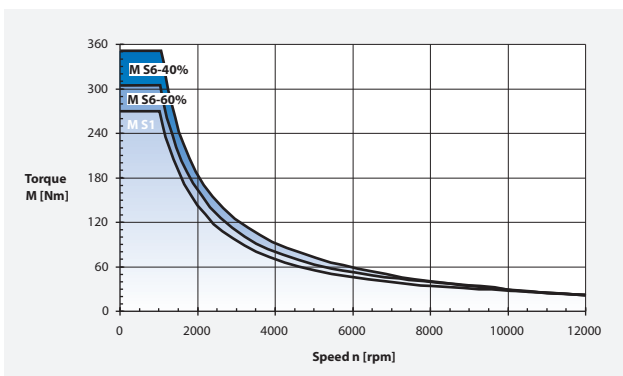
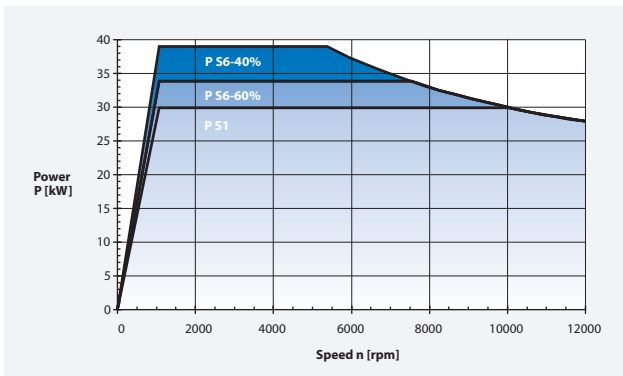
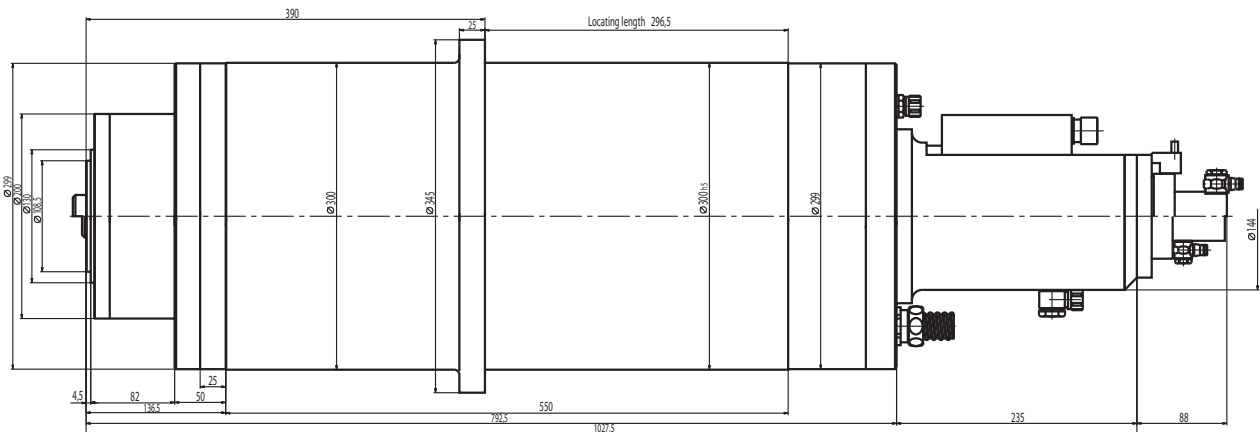

Asynchronous motor

Power P (S1)	30 kW at 1,000 rpm
Torque M (S1)	270 Nm
Speed n_{max}	12,000 rpm
Drive	closed-loop

Hybrid ball bearings

Bore diameter	
of front bearings	110 mm
Lubrication	Oil/air

Tool interface

Interface	HSK-A 100
Monitoring	
"clamped", "unclamped",	
"clamped without tool"	Analog sensor
Taper cleaning	Air
Static tool pull-in force	45 kN

Seal

Coolant

through shaft	50 bar
---------------------	--------

Rigidity

Radial	955 N/ μ m
Axial	607 N/ μ m

Also available with permanent grease lubrication. This lubrication leads to speed reduction.

HCS 300 - 14000/45

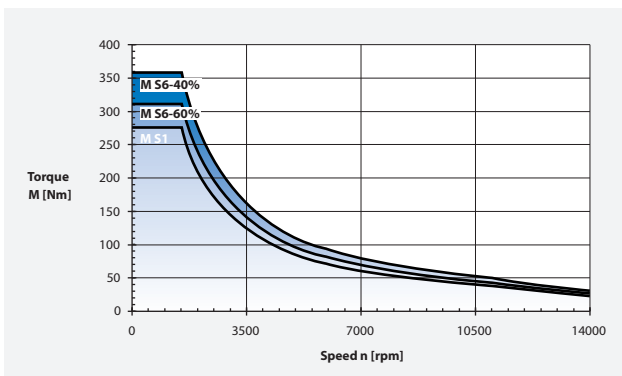
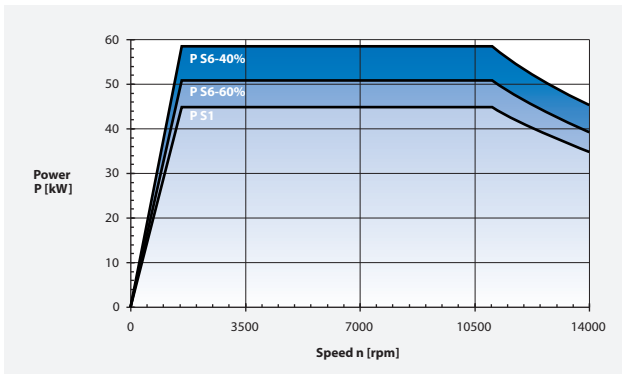
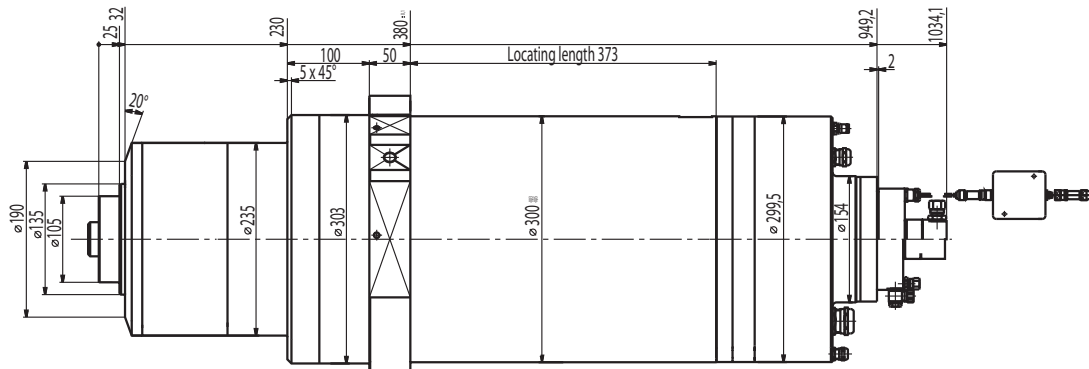

Asynchronous motor

Power P (S1)	45 kW at 1,560 rpm
Torque M (S1)	275 Nm
Speed n_{max}	14,000 rpm
Drive	closed-loop

Hybrid ball bearings

Bore diameter	
of front bearings	110 mm
Lubrication	Oil/air

Tool interface

Interface	HSK-A 100
Monitoring	
"clamped", "unclamped",	
"clamped without tool"	Analog sensor
Taper cleaning	Air
Static tool pull-in force	45 kN

Seal

Coolant

through shaft	80 bar
through spindle housing	10 bar

Shaft movement

Compensating - Axial	Temperature sensor
----------------------------	--------------------

Rigidity

Radial	550 N/ μ m
Axial	540 N/ μ m

Option

Shaft movement sensor	
Vibration sensor	

Also available with permanent grease lubrication. This lubrication leads to speed reduction.

HCS 310 - 12000/25

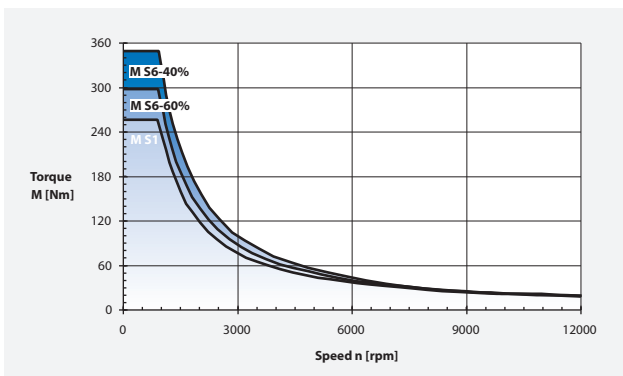
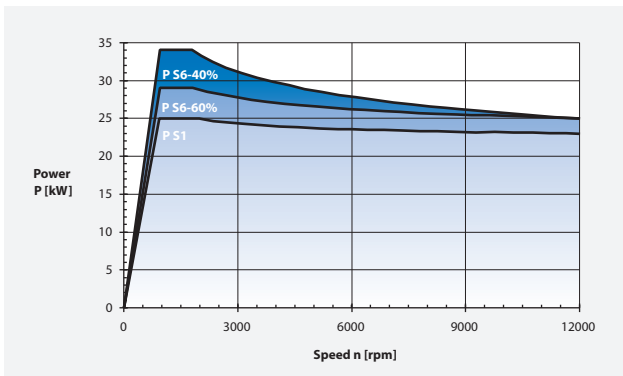
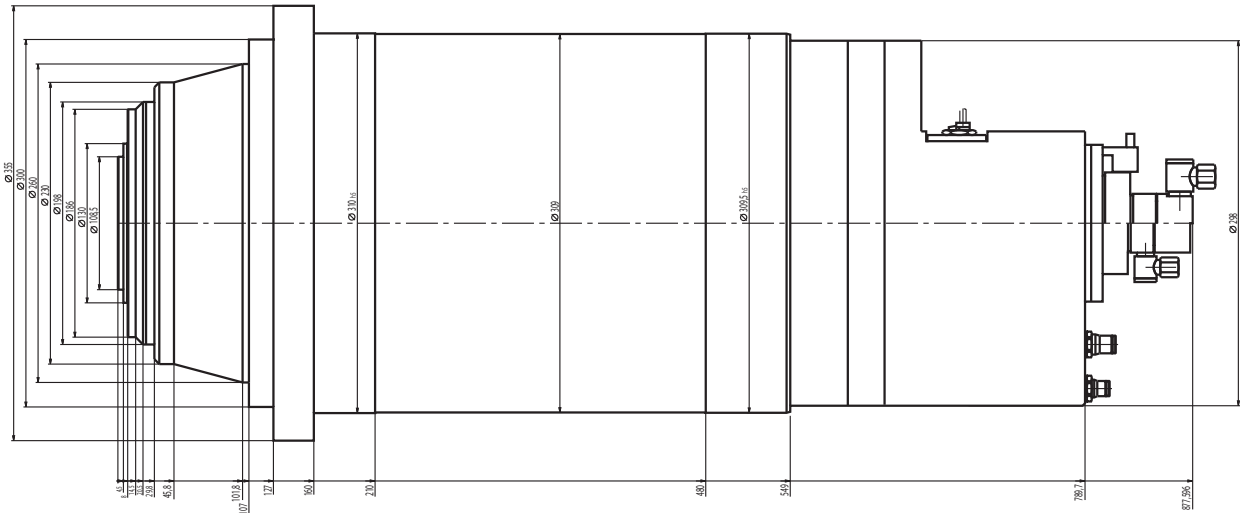

Asynchronous motor

Power P (S1)	25 kW at 930 rpm
Torque M (S1)	256.7 Nm
Speed n_{max}	12,000 rpm
Drive	closed-loop

Hybrid ball bearings

Bore diameter	
of front bearings	110 mm
Lubrication	Oil/air

Tool interface

Interface	HSK-A 100
Monitoring	
"clamped", "unclamped",	
"clamped without tool"	Proximity switches
Taper cleaning	Air
Static tool pull-in force	45 kN

Seal

Coolant

through shaft

Shaft movement

Compensating - Axial

Rigidity

Radial	1,012 N/ μ m
Axial	607 N/ μ m

Also available with permanent grease lubrication. This lubrication leads to speed reduction.

HCS 320 - 8000/40

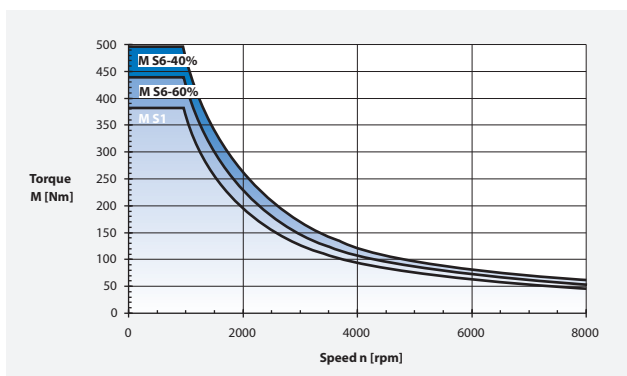
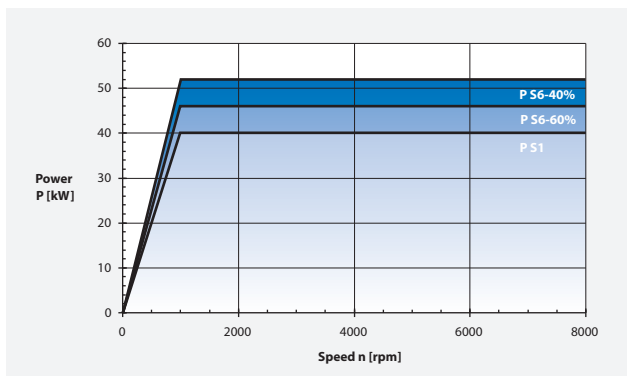
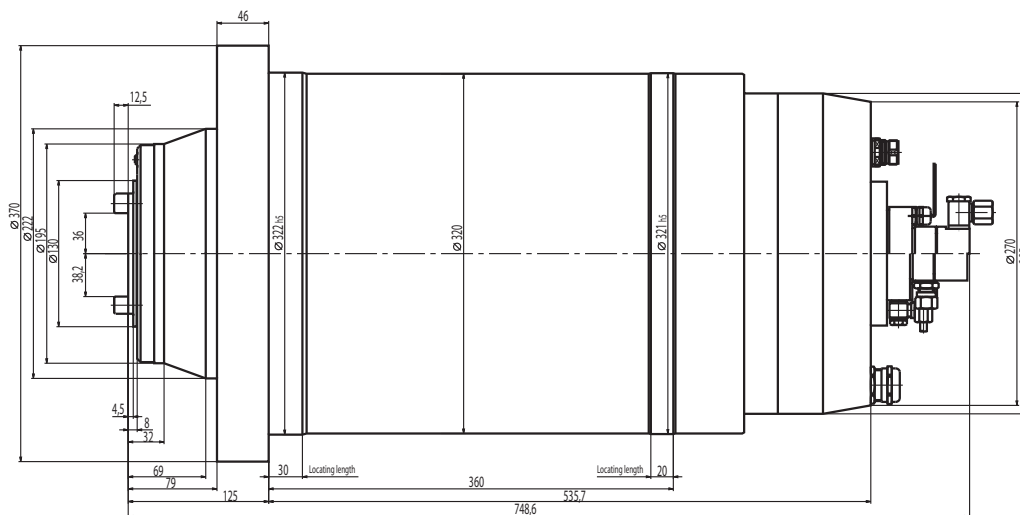

Asynchronous motor

Power P (S1)	40 kW at 1,050 rpm
Torque M (S1)	380 Nm
Speed n_{max}	8,000 rpm
Drive	closed-loop

Hybrid ball bearings

Bore diameter	
of front bearings	110 mm
Lubrication	Oil/air

Tool interface

Interface	SK 50
Monitoring	
"clamped", "unclamped",	
"clamped without tool"	Analog sensor
Taper cleaning	Air
Static tool pull-in force	25 kN

Seal

Coolant

through shaft	80 bar
through spindle housing	3 bar

Rigidity

Radial	760 N/ μ m
Axial	350 N/ μ m

Also available with permanent grease lubrication. This lubrication leads to speed reduction.