

SYNCHROFLEX® TIMING BELTS

in Polyurethane with Steel Tension Members

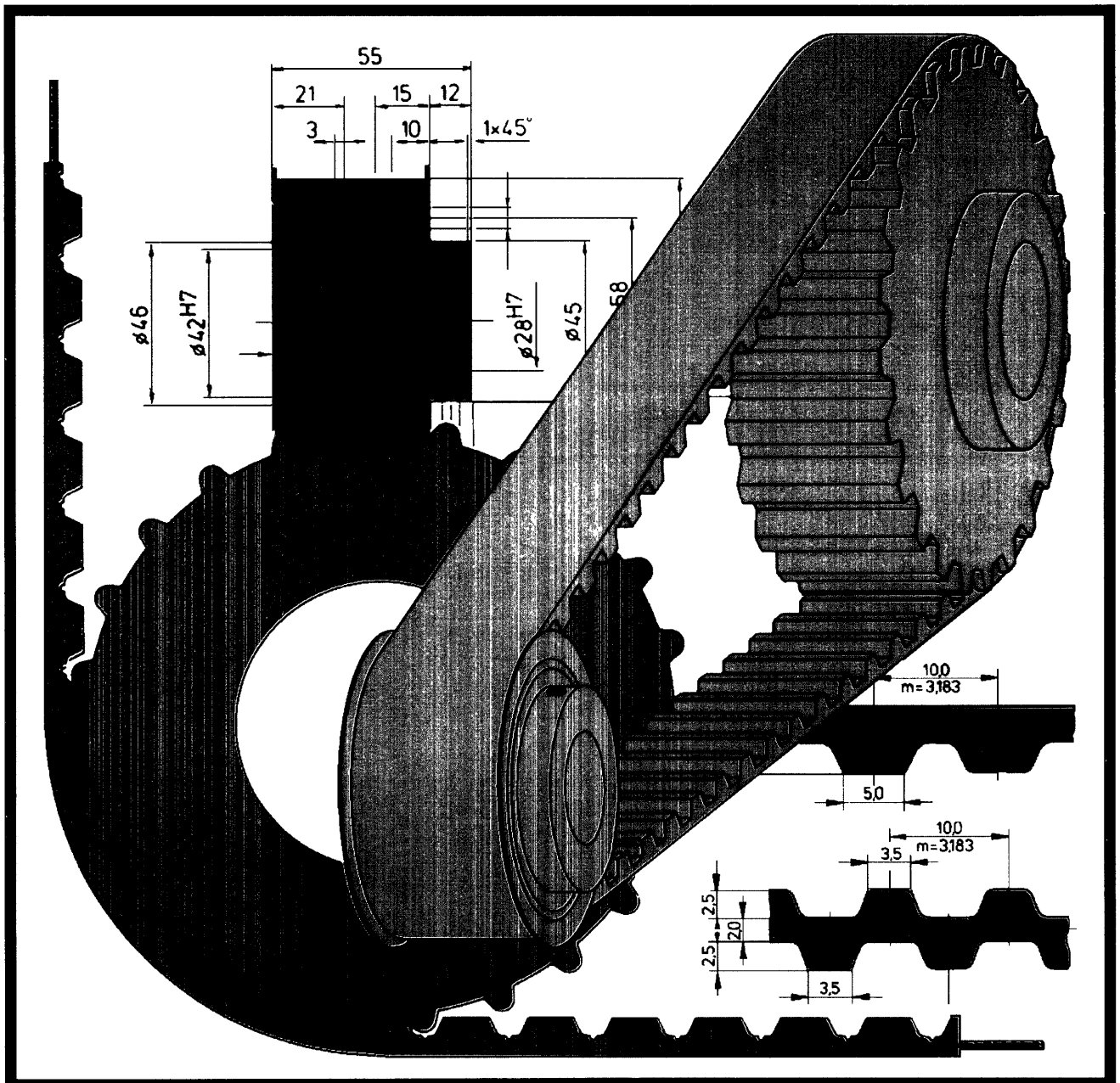

® registered trademark of **Continental**® Gummi-Werke AG

TRANSMISSION DEVELOPMENTS CO (GB) LTD
DAWKINS ROAD, HAMWORTHY, POOLE, DORSET BH15 4HS TEL: 0202 675555 FAX: 0202 677466





Timing Belt Drives

Our expertise in the area of power transmission includes:

- technical advice
- complete design of drives
- experienced technical staff
- extensive stock

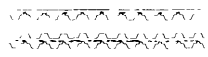
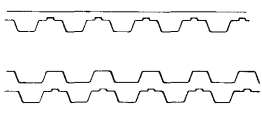
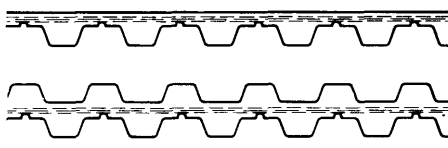
Complete solutions for all types of drives coupled with unequalled service is our strong point.

Timing Belts

T 2 Typ M T 2,5	Power rating	≤ 0.5 kW	
	R.P.M.	≤ 40 000 min ⁻¹	
	Peripheral speed	≤ 80 ms ⁻¹	
	Timing pulleys	from z = 10	
	Typical applications	Precision drives, Camera drives, Control drives	
T 5	Power rating	≤ 5 kW	
	R.P.M.	≤ 40 000 min	
	Peripheral speed	≤ 80 ms	
	Timing pulleys	from z = 10	
	Typical applications	Office machinery, Kitchen machinery, Tacho drives, Control and regulator drives	
T 10	Power rating	≤ 30 kW	
	R.P.M.	≤ 15 000 min ⁻¹	
	Peripheral speed	≤ 60 ms ⁻¹	
	Timing pulleys	from z = 12	
	Typical applications	Machine tools, primary and auxiliary drives, Textile machinery, Printing machinery	
T 20	Power rating	to approx. 100 kW	
	R.P.M.	≤ 6 000 min ⁻¹	
	Peripheral speed	≤ 40 ms ⁻¹	
	Timing pulleys	from z = 15	
	Typical applications	Heavy construction machinery, Paper-making machinery, Pumps, Compressors, Textile machinery	
AT 5	Power rating	≤ 8 kW	
	R.P.M.	≤ 12 000 min ⁻¹	
	Peripheral speed	≤ 60 ms ⁻¹	
	Timing pulleys	from z = 12	
	Typical applications	Machine tools, Pumps, Textile machinery	
AT 10	Power rating	≤ 70 kW	
	R.P.M.	≤ 8 000 min ⁻¹	
	Peripheral speed	≤ 40 ms ⁻¹	
	Timing pulleys	from z = 15	
	Typical applications	Construction machinery, Pumps, Paper machinery, Compressors, Textile machinery, Roll table drives	
AT 20	Power rating	over 200 kW	
	R.P.M.	≤ 5 000 min ⁻¹	
	Peripheral speed	≤ 30 ms ⁻¹	
	Timing pulleys	from z = 18	
	Typical applications	Heavy drives, Textile machinery, Printing plant, Machine tools	

Timing Pulleys

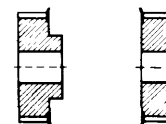

can be supplied together with Timing Belts as complete drives.

SYNCHROFLEX® timing belts are suitable for all kinds of drives. Multi-shaft drives are feasible with polyurethane timing belts due to the flexibility of the belt material and the high flexural strength of the steel tension members.

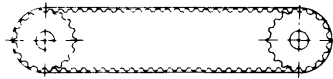

$i=1$

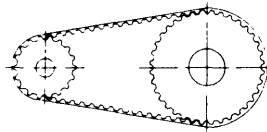

$i+1$

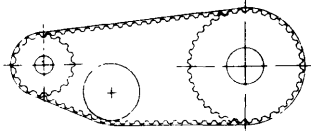

Jockey pulley inside

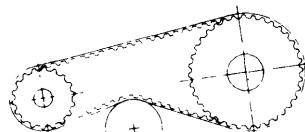

Jockey pulley outside

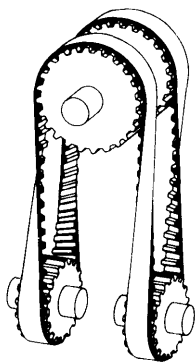

Angular drives

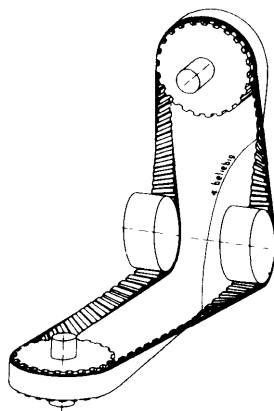

The centre distance should not be too small. A suitable guide value is $15 \times$ the belt width.

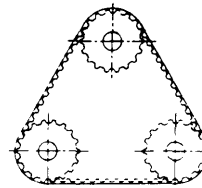

Triangular drive

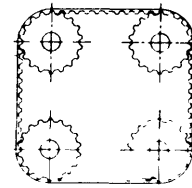

Square drive

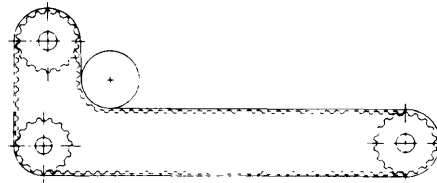

Deflection drive

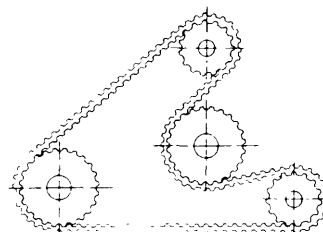

Reversing drive

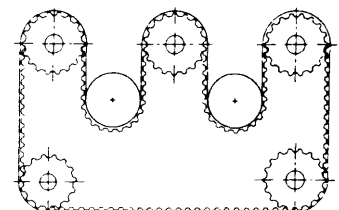

Multi-shaft drive

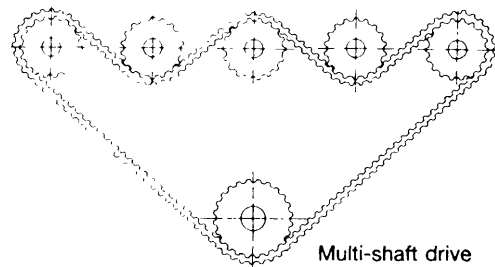

Multi-shaft drive

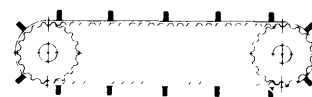

Conveyor belt with cams

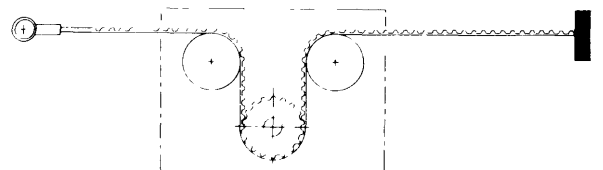

Reversing drive

With different or complicated drives please consult our technical dept.

Construction of Synchronflex® Timing Belts

SYNCHROFLEX® Timing Belts consist of only two components, the wear-resistant polyurethane Contilan and the high grade steel wire tension members. The excellent bond between the two results in a high flank load capacity combined with low elastic elongation. The manufacturing process produces close tolerance timing belts which ensure a uniform number of teeth in mesh during power transmission. The tooth profiles of both belts and pulleys ensure optimum mesh in all power ranges and have proved themselves in operation for more than 30 years. SYNCHROFLEX® timing belts comply with DIN 7721 (Sheet 1).

Single-sided SYNCHROFLEX® timing belt

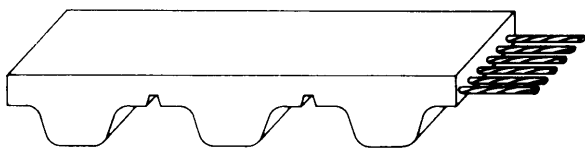

Double-sided SYNCHROFLEX® timing belt

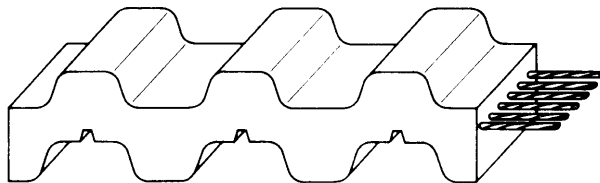

Characteristics of Synchronflex® Timing Belts

mechanical:

stable, synchronous
constant length, no post-elongation
reduced noise
abrasion resistant
maintenance-free
highly flexible
positionally accurate, radially accurate
dihedral applicable
high fatigue strength, high stiffness tension members
belt speed up to 80 m/sec.
low inertia
optimum power/weight ratio
low initial tension
low bearing loads
fixed centres possible
large centres possible
large ratios feasible
efficiency up to 98 %

Chemical:

can be welded to other thermoplastics
hydrolysis resistant
chemically stable
temperature range from -30° to $+80^{\circ}$ C,
temporarily higher ($+120^{\circ}$ C)
tropic-proof
resistant to oils, grease and petrol
conditionally resistant to acids and alkalis

Open Length Synchroflex® Timing Belts

in Polyurethane with Kevlar Tension Members

K 1,5

Serration

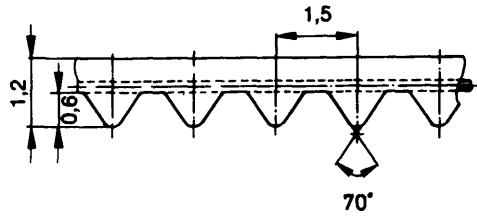

high torsional angular accuracy

T 2

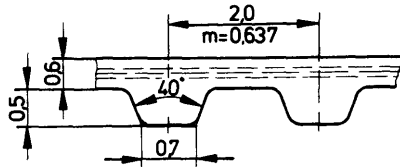

M

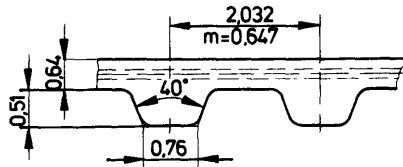

T 2,5

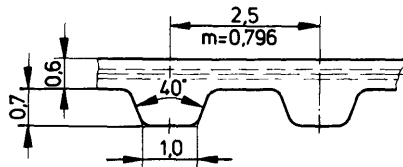

Applications:

- Precision engineering
- Electronic data processing equipment
- Office machinery
- Drawing machinery
- Handling equipment
- Linear drives

Characteristics:

- repetitively accurate
- high torsional angular accuracy
- stable
- highly flexible
- abrasion resistant
- oil resistant
- reduced noise
- low initial tension
- low inertia
- maintenance-free

Belt width width tolerances $\pm 0,3$ mm intermediate widths on request	b (mm)	4*	6*	8	10*	12	14	16
Pulley width B (mm)		8	10	12	14	16	18	20
Maximum allowable tensile force (N) related to 0,4 % elastic elongation		24	40	64	80	104	120	144
Maximum deliverable lengths (mm)		15 000	12 000	10 000	8 000	7 000	6 000	5 000

Stock

Ordering examples:

Synchroflex Timing Belt T 2,5

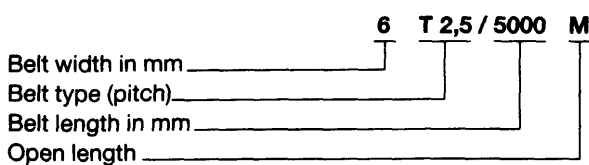

Timing pulley T 2,5 for belt width of 6 mm from stock

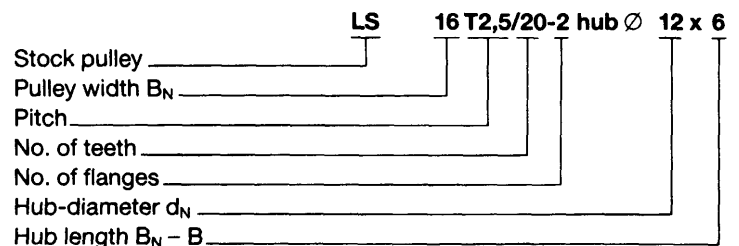

K 1,5

Serration

Synchroflex® Timing Belts

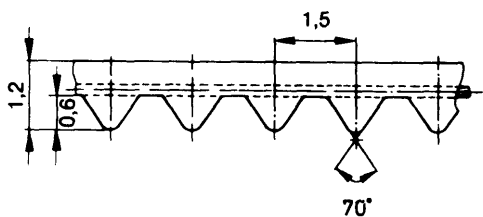

Ordering example

6	K 1,5 / 100
Width (mm)	Pitch / Length (mm)

Standard Belt width b (mm)	4	6	10
----------------------------	---	---	----

Intermediate and larger widths available

Type	Belt Length (mm)	No. of teeth Z_B
K 1,5/57		
K 1,5/64		
K 1,5/100	100,5	67
K 1,5/201	201	134
K 1,5/300	300	200
K 1,5/400	400,5	267
K 1,5/501	501	334
K 1,5/600	600	400
K 1,5/1242	1242	828

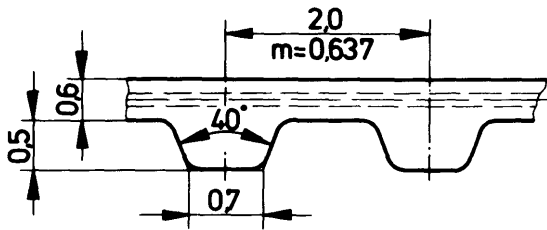

Ordering example

6	T 2/240
Width (mm)	Pitch/Length (mm)

Type	Belt Length (mm)	No. of teeth Z_B
T 2/ 90	90	45
T 2/118	118	59
T 2/120	120	60
T 2/138	138	69
T 2/140	140	70
T 2/144	144	72
T 2/150	150	75
T 2/160	160	80
T 2/180	180	90
T 2/200	200	100
T 2/220	220	110
T 2/240	240	120
T 2/256	256	128
T 2/280	280	140
T 2/292	292	146
T 2/320	320	160
T 2/360	360	180
T 2/600	600	300
T 2/710	710	355

Standard Belt width b (mm)	4	6	10
----------------------------	---	---	----

Intermediate and larger widths available

M Synchroflex® Timing Belts

corresponds to Minipitch 2.032 mm (0,080") pitch

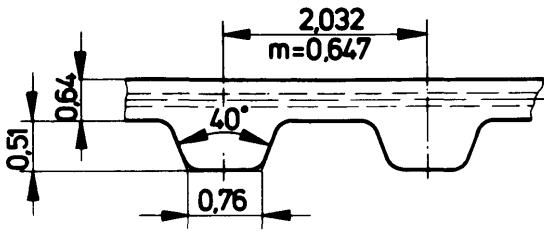

Ordering example

6	M 182
Width (mm)	Pitch/Length (mm)

Type	Belt Length (mm)	No. of teeth Z_B
M 111	111,76	55
M 113	113,79	56
M 121	121,92	60
M 132	132,08	65
M 142	142,24	70
M 144	144,27	71
M 162	162,56	80
M 182	182,88	90
M 203	203,20	100
M 209	209,30	103
M 213	213,36	105
M 243	243,86	120
M 256	256,03	126
M 264	264,16	130
M 284	284,48	140
M 304	304,80	150
M 355	355,60	175
M 373	373,89	184
M 449	449,07	221
M 503	503,94	248
M 520	520,19	256
M 599	599,40	295
M 731	731,52	360
M 1178	1178,56	580

Standard Belt width b (mm)	4	6	10
----------------------------	---	---	----

Intermediate and larger widths available

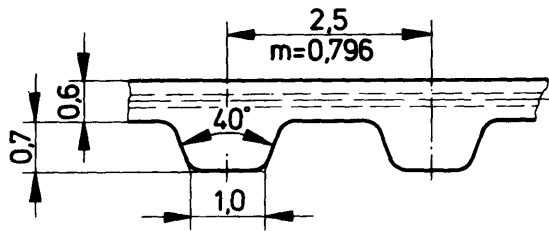

Ordering example

10	T 2,5/380
Width (mm)	Pitch/Length (mm)

DL

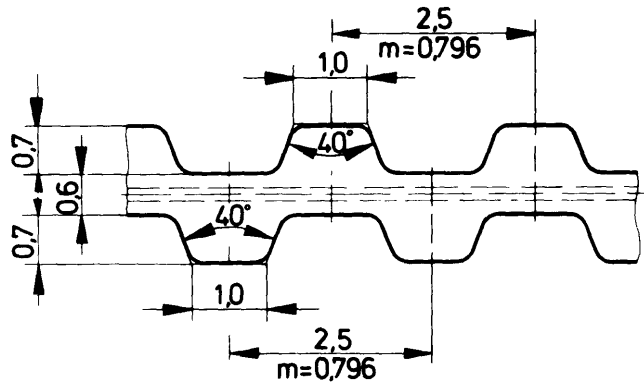

Ordering example

10	T 2,5/457,5 - DL
Width (mm)	Pitch/Length (mm) - double-sided

Standard Belt width b (mm)	4	6	10
----------------------------	---	---	----

intermediate and larger widths available

T 2,5 Belt length	T 2,5-DL Belt length	No. of teeth Z_B
T 2,5/ 55		22
T 2,5/ 120		48
T 2,5/ 145		58
T 2,5/ 160		64
T 2,5/ 177,5		71
T 2,5/ 180		72
T 2,5/ 182,5		73
T 2,5/ 200		80
T 2,5/ 210		84
T 2,5/ 230		92
T 2,5/ 245		98
T 2,5/ 265		106
T 2,5/ 285		114
T 2,5/ 290		116
T 2,5/ 317,5	T 2,5/317,5-DL	127
T 2,5/ 330		132
T 2,5/ 380		152
T 2,5/ 420		168
T 2,5/ 480	T 2,5/457,5-DL	183
T 2,5/ 500		192
T 2,5/ 540		200
T 2,5/ 540		216
T 2,5/ 600		240
T 2,5/ 620		248
T 2,5/ 650		260
T 2,5/ 780		312
T 2,5/ 950		380
T 2,5/1300		520

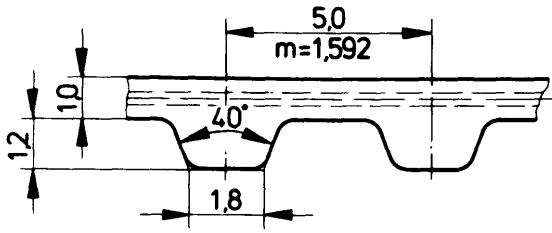

Ordering example

10	T 5/455
Width (mm)	Pitch/Length (mm)

DL

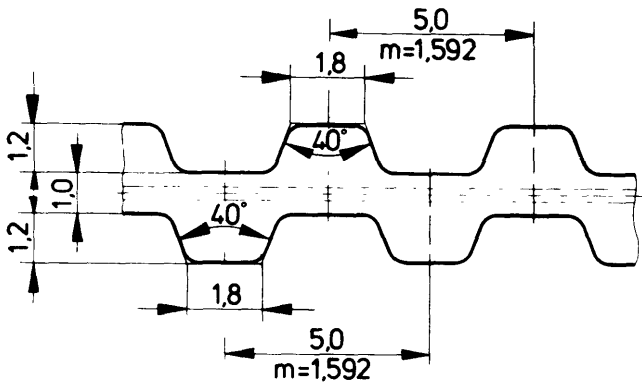

Ordering example

10	T 5/460 - DL
Width (mm)	Pitch/Length (mm) - double-sided

Standard Belt width b (mm)	6	10	16	25
----------------------------	---	----	----	----

intermediate and larger widths available

T 5 Belt length	T 5-DL Belt length	No. of teeth Z_B
T 5/ 100		20
T 5/ 150	T 5/ 150-DL	30
T 5/ 165		33
T 5/ 180		36
T 5/ 185		37
T 5/ 200		40
T 5/ 210		42
T 5/ 215		43
T 5/ 220		44
T 5/ 225		45
T 5/ 245		49
T 5/ 250		50
T 5/ 255		51
T 5/ 260	T 5/ 260-DL	52
T 5/ 270		54
T 5/ 280		56
T 5/ 295		59
T 5/ 305		61
T 5/ 330		66
T 5/ 340		68
T 5/ 355		71
T 5/ 365		73
T 5/ 390		78
T 5/ 400		80
T 5/ 410	T 5/ 410-DL	82
T 5/ 420		84
T 5/ 455		91
	T 5/ 460-DL	92
T 5/ 480		96
T 5/ 500		100
T 5/ 505		101
T 5/ 510		102
	T 5/ 515-DL	103
T 5/ 525	T 5/ 525-DL	105
T 5/ 545		109
T 5/ 550		110
T 5/ 560		112
T 5/ 575		115
T 5/ 590	T 5/ 590-DL	118
T 5/ 610		122
T 5/ 620	T 5/ 620-DL	124
	T 5/ 625-DL	125
T 5/ 630		126
T 5/ 650		130
T 5/ 690		138
T 5/ 700		140
T 5/ 720		144
T 5/ 725		145
T 5/ 750	T 5/ 750-DL	150
T 5/ 765		153
T 5/ 780		156
T 5/ 815	T 5/ 815-DL	163
T 5/ 840		168
	T 5/ 860-DL	172
T 5/ 900		180
T 5/ 920		184
T 5/ 925		185
T 5/ 940	T 5/ 940-DL	188
T 5/ 990		198
T 5/1075		215
T 5/1100	T 5/1100-DL	220
T 5/1160		232
T 5/1215		243
T 5/1315		263
	T 5/1325-DL	265
T 5/1380		276

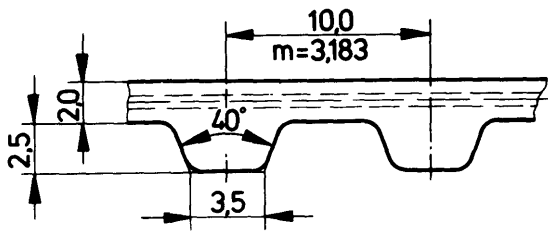

Ordering example

16	T 10/260
Width (mm)	Pitch/Length (mm)

DL

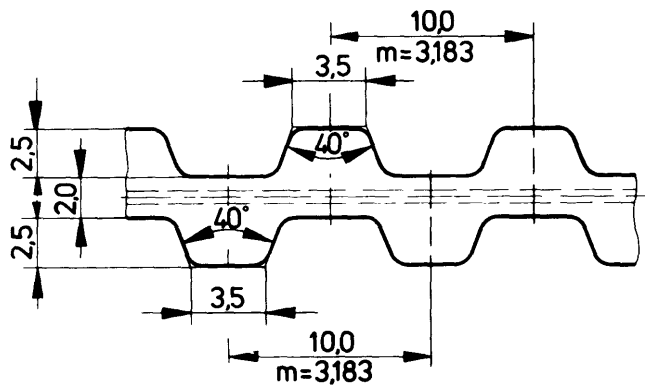

Ordering example

16	T 10/260 - DL
Width (mm)	Pitch/Length (mm) - double-sided

Standard Belt width b (mm)	16	25	32	50
----------------------------	----	----	----	----

intermediate and larger widths available

T 10 Belt length	T 10 - DL Belt length	No of teeth Z_B
T 10/ 260	T 10/ 260-DL	26
T 10/ 370		37
T 10/ 410		41
T 10/ 440		44
T 10/ 500		50
T 10/ 530	T 10/ 530-DL	53
T 10/ 560		56
T 10/ 600		60
T 10/ 610		61
T 10/ 630	T 10/ 630-DL	63
T 10/ 660	T 10/ 660-DL	66
T 10/ 680		68
T 10/ 690		69
T 10/ 700		70
T 10/ 720	T 10/ 720-DL	72
T 10/ 730		73
T 10/ 750		75
T 10/ 780		78
T 10/ 810		81
T 10/ 840	T 10/ 840-DL	84
T 10/ 850		85
T 10/ 880		88
T 10/ 890		89
T 10/ 920		92
T 10/ 960		96
T 10/ 970		97
T 10/ 980	T 10/ 980-DL	98
T 10/1010		101
T 10/1080		108
T 10/1110		111
T 10/1140		114
T 10/1150		115
T 10/1210	T 10/1210-DL	121
T 10/1240	T 10/1240-DL	124
T 10/1250	T 10/1250-DL	125
T 10/1300		130
T 10/1320	T 10/1320-DL	132
T 10/1350	T 10/1350-DL	135
T 10/1390		139
T 10/1400		140
T 10/1420	T 10/1420-DL	142
T 10/1450		145
T 10/1460		146
T 10/1500		150
T 10/1560		156
T 10/1610	T 10/1610-DL	161
T 10/1750		175
T 10/1780		178
T 10/1880	T 10/1880-DL	188
T 10/1960		196
T 10/2250		225
T 10/3100		310
T 10/4780	*T 10/4780-DL	478

* for applications involving T 10/4780 - DL please contact our Technical dept.

T 20

DIN 7721

Synchroflex® Timing Belts

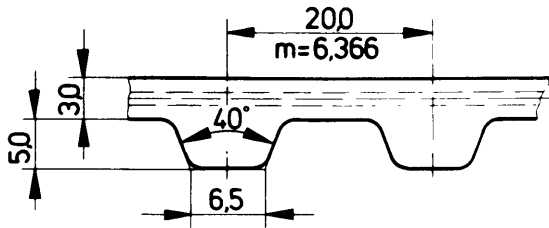

Ordering example

50	T 20/2600
Width (mm)	Pitch/Length (mm)

DL

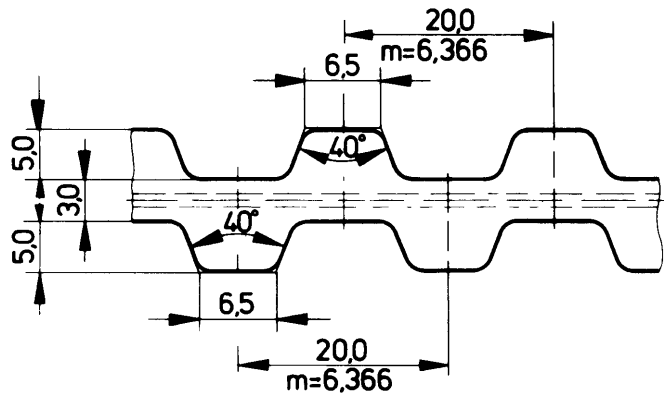

Ordering example

50	T 20/2600 - DL
Width (mm)	Pitch/Length (mm) - double-sided

T 20 Belt length	T 20 - DL Belt length	No of teeth Z_B
T 20/1260		63
T 20/1460		73
T 20/1780		89
T 20/1880		94
T 20/2360		118
T 20/2600	*T 20/2600 - DL	130
T 20/3100		155
T 20/3620	*T 20/3620 - DL	181

Standard Belt width b (mm)	32	50	75	100
----------------------------	----	----	----	-----

intermediate and larger widths available

* for applications involving T 20/2600 - DL and T 20/3620 - DL please contact our Technical dept.

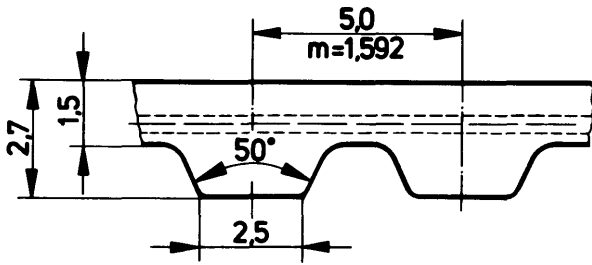

Ordering example

10	AT 5/450
Width (mm)	Pitch/Length (mm)

Type		No. of teeth Z_B
AT 5/ 225	225	45
AT 5/ 255	255	51
AT 5/ 260	260	52
AT 5/ 280	280	56
AT 5/ 300	300	60
AT 5/ 330	330	66
AT 5/ 340	340	68
AT 5/ 375	375	75
AT 5/ 390	390	78
AT 5/ 420	420	84
AT 5/ 450	450	90
AT 5/ 455	455	91
AT 5/ 480	480	96
AT 5/ 500	500	100
AT 5/ 525	525	105
AT 5/ 545	545	109
AT 5/ 600	600	120
AT 5/ 610	610	122
AT 5/ 620	620	124
AT 5/ 660	660	132
AT 5/ 710	710	142
AT 5/ 720	720	144
AT 5/ 750	750	150
AT 5/ 780	780	156
AT 5/ 825	825	165
AT 5/ 860	860	172
AT 5/ 975	975	195
AT 5/1050	1050	210
AT 5/1125	1125	225
AT 5/1500	1500	300
AT 5/1750	1750	350
AT 5/2000	2000	400

Standard Belt width b (mm)	10	16	25	32	50
----------------------------	----	----	----	----	----

intermediate and larger widths available

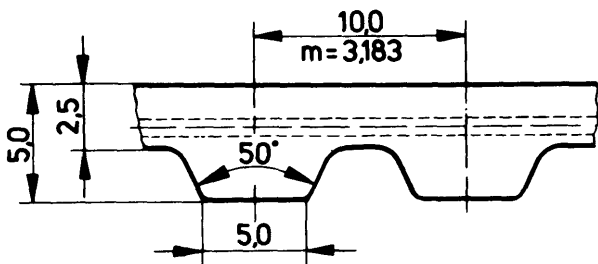

Ordering example

32	AT 10/800
Width (mm)	Pitch/Length (mm)

Type	Belt length (mm)	No of teeth Z_B
AT 10/ 500	500	50
AT 10/ 560	560	56
AT 10/ 600	600	60
AT 10/ 610	610	61
AT 10/ 660	660	66
AT 10/ 700	700	70
AT 10/ 730	730	73
AT 10/ 780	780	78
AT 10/ 800	800	80
AT 10/ 840	840	84
AT 10/ 890	890	89
AT 10/ 920	920	92
AT 10/ 960	960	96
AT 10/ 980	980	98
AT 10/1000	1000	100
AT 10/1010	1010	101
AT 10/1050	1050	105
AT 10/1080	1080	108
AT 10/1100	1100	110
AT 10/1150	1150	115
AT 10/1200	1200	120
AT 10/1210	1210	121
AT 10/1250	1250	125
AT 10/1280	1280	128
AT 10/1300	1300	130
AT 10/1320	1320	132
AT 10/1350	1350	135
AT 10/1360	1360	136
AT 10/1400	1400	140
AT 10/1480	1480	148
AT 10/1500	1500	150
AT 10/1600	1600	160
AT 10/1700	1700	170
AT 10/1720	1720	172
AT 10/1800	1800	180
AT 10/1860	1860	186
AT 10/1940	1940	194

Standard Belt width b (mm)	25	32	50	75	100
----------------------------	----	----	----	----	-----

intermediate and larger widths available

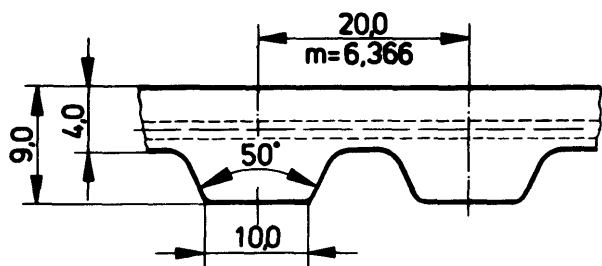

Ordering example

50	AT 20/1500
Width (mm)	Pitch/Length (mm)

Type	Belt length (mm)	No of teeth Z_B
AT 20/1000	1000	50
AT 20/1100	1100	55
AT 20/1200	1200	60
AT 20/1260	1260	63
AT 20/1500	1500	75
AT 20/1600	1600	80
AT 20/1700	1700	85
AT 20/1760	1760	88
AT 20/1800	1800	90
AT 20/1900	1900	95
AT 20/1960	1960	98

Standard Belt width b (mm)	32	50	75	100
----------------------------	----	----	----	-----

intermediate and larger widths available

Special designs

Synchroflex® Timing belts with special profiles, e. g. with dogs or cams on the back of the belt, offer the designer unlimited possibilities. Available for conveying, guiding or positioning.

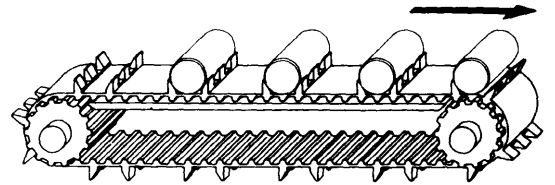

Synchroflex Timing Belts with moulded profiles:

Extreme accuracy can be achieved through the manufacture of tooling. Particular customer requirements in respect to the shape of the profiles and their quantity can be taken into account in the design of new tooling.

Examples of Synchroflex® timing belts with moulded profiles:

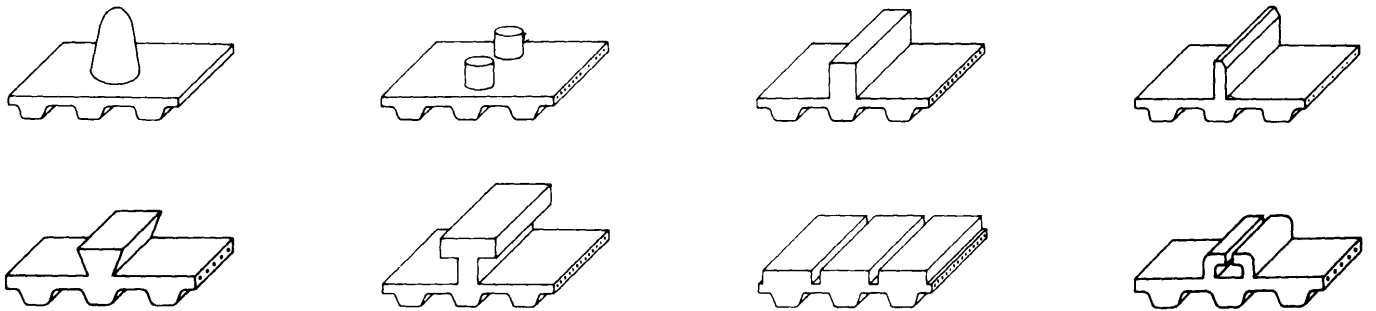

Synchroflex® Timing Belts with welded-on profiles:

Examples of possible forms:

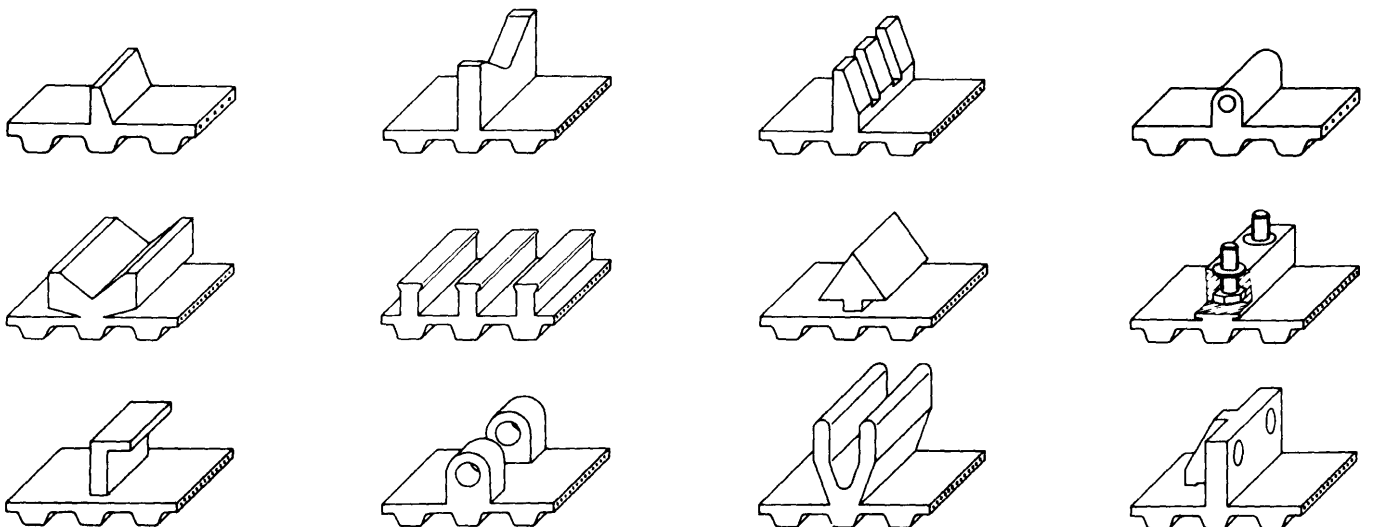

The first batch of profiles are also available as welded-on profiles.

Synchroflex® Timing Belt with back coverings

Should there be special requirements as to the belt back covering the undermentioned materials can be supplied.

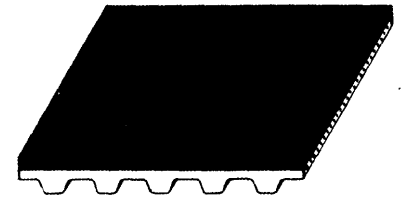

Description	Linatex	Porol	Vulkollan Foam	Supergrip
Type of material	Natural rubber	Cellular rubber	Foam polyurethane	PVC
Colour	red	black	yellow-brown	blue-green with indentations
Hardness	approx. 40° Shore A	approx. 15° Shore A	approx. 40° Shore A	approx. 30° Shore A
Technical Properties	limited abrasion resistance, high coefficient of friction.	not abrasion resistant, high coefficient of friction.	good abrasion resistance, high coefficient of friction.	limited wear high coefficient of friction.
Applications	tractor haul-offs and all types of transport drives.	all types of light transport drives.	glass and paper industry	good for inclined conveyance

Description	Friction material with pips	HV 1-Strip	Rubber Correx beige
Type of material	PVC	Polyurethane	Artificial Rubber
Colour	white	transparent	beige
Hardness	approx. 40° Shore A	approx. 80° Shore A	approx. 35 – 40° Shore A
Technical Properties	limited wear. high coefficient of friction.	good abrasion resistance.	abrasion resistant, good grip.
Applications	good for inclined conveyance and food industry.	food industry	all types of transport drives.

Further types on request.

Special designs

Synchroflex® Timing Belts with ground backs

Belt backs can be ground to tighter tolerances after manufacture.

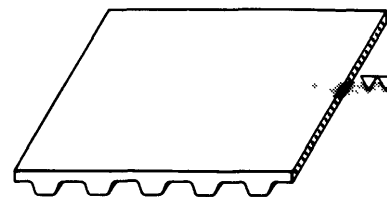

Synchroflex® Timing Belts with special tooth sections

For special applications the teeth can be arranged in many different permutations

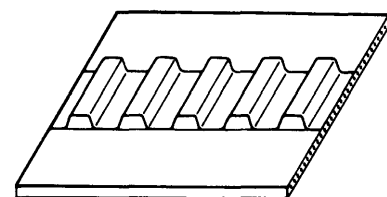

Synchroflex® Timing Belts with an anti-static covering

Anti-static conductance makes it possible to safely dissipate electrostatic build-up, i. e. in the transport of electronic components. With timing belts of inadequate conductance the build-up can be so considerable that an electrical discharge can result. With applications in explosive atmospheres please consult our Technical dept.

Obtainable conductance $12 \cdot 6 \leq 10^5 \Omega m$

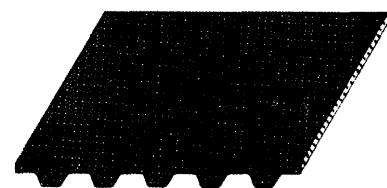

Backlash-free Drives

Frequently a backlash-free drive is required. Depending on the application the backlash can be reduced to a greater or lesser degree. The following points should be taken into account:

1. The normal width of the tooth gap should be reduced.
2. The initial tension of the belt should be higher.
3. Drives should be designed with a greater safety factor in order to give greater stiffness and reduce elastic elongation.

For the calculation of backlash-free drives the following parameters should be taken into account:

Power
R. P. M.
No. of teeth in mesh

Please consult our Technical dept.

Ordering examples for Synchroflex Timing Pulleys

This page is intended to be a guide to the formula for ordering Synchroflex timing pulleys. For simple timing pulleys no drawings are necessary. The dimensions given are in mm.

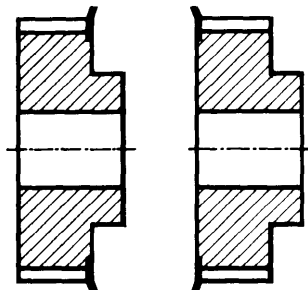

The number of flanges as 0,1 or 2. If a timing pulley with a hub is to have only one flange please specify as follows:

Flange on hub side (fig. left)
Flange opposite to hub side (fig. right)

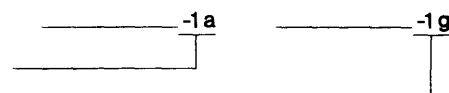

Example: Timing pulley with hub for a belt width of 10 mm.

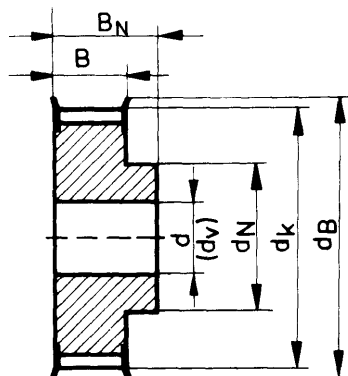

Material steel
Pulley width B_N
Pitch
No. of teeth
No. of flanges
Hub diameter
Hub length $B_N - B$
Bore d e.g pilot bored d_N

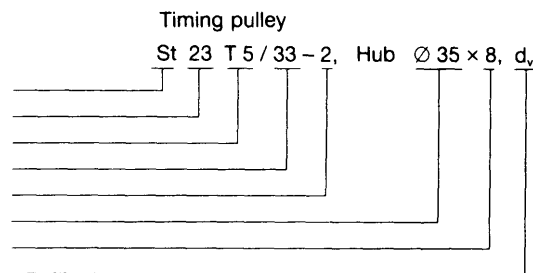

Example: Timing pulley without hub for a belt width of 10 mm.

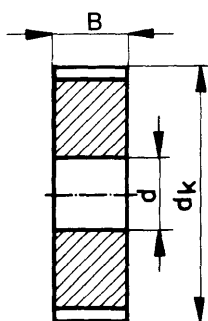

Material aluminium
Pulley width B
Pitch
No. of teeth
No. of flanges
Bore d
Keyway to DIN 6885

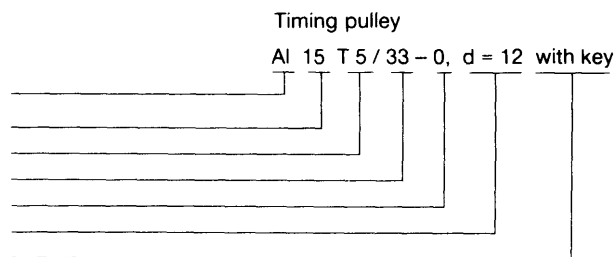

IMPORTANT ORDERING INFORMATION

- Bores:** Stock pulleys are supplied either pilot bored or unbored. If the pulley is to be supplied finished bored please specify diameter and tolerance required at time of order.
- Fixings:** If a fixing is required (eg, a grub screw) specify both dimension and position.
Example: Synchroflex timing pulley AL21 T5 / 33 - 2, Hub dia 35 x 6, d = 12 H7, tapped M4 central in hub.
- Drawings:** For specific finished and dimensional tolerances it is advisable to provide drawings.
- Flanges:** Unless specified at time of order, flange dimensions and finish may vary from that described herein.

K 1,5 / T 2 / M / T 2,5 7792520-7092035 Stock Timing Pulleys

Material: Al Cu Mg Pb

Type	No. of teeth z	Outside diameter mm	d_B mm	Tooth width B mm	Total width B_N mm	Bored H7 without Keyway mm	Specification	
K 1,5 Belt width b = 6 mm	20	9,08	—	16	16	3	LS 16 K 1,5/20-0	
	24	10,99	—	16	16	3	LS 16 K 1,5/24-0	
	32	14,81	18	10	16	3	LS 16 K 1,5/32-2 Nabe Ø 10x6	
	48	22,45	26	10	16	4	LS 16 K 1,5/48-2 Nabe Ø 14x6	
T 2 Belt width b = 6 mm	15	9,00	—	16	16	3	LS 16 T 2 /15-0	
	16	9,64	—	16	16	3	LS 16 T 2 /16-0	
	20	12,18	—	16	16	3	LS 16 T 2 /20-0	
	24	14,73	18	10	16	3	LS 16 T 2 /24-2 Nabe Ø 10x6	
	32	19,82	24	10	16	4	LS 16 T 2 /32-2 Nabe Ø 14x6	
	48	30,01	35	10	16	4	LS 16 T 2 /48-2 Nabe Ø 20x6	
M Belt width b = 6 mm	15	9,19	—	16	16	3	LS 15 M /16-0	
	16	9,83	—	16	16	3	LS 16 M /16-0	
	20	12,42	—	16	16	3	LS 16 M /20-0	
	24	15,01	18	10	16	3	LS 16 M /24-2 Nabe Ø 10x6	
	32	20,19	24	10	16	4	LS 16 M /32-2 Nabe Ø 14x6	
	48	30,53	35	10	16	4	LS 16 M /48-2 Nabe Ø 20x6	
T 2,5 Belt width b = 6 mm	10	7,45	10	10	16	3	LS 16 T 2,5 /10-2 Nabe Ø 10x6	
	12	9,00	13	10	16	3	LS 16 T 2,5 /12-2 Nabe Ø 12x6	
	14	10,60	14	10	16	3	LS 16 T 2,5 /14-2 Nabe Ø 14x6	
	15	11,40	15	10	16	3	LS 16 T 2,5 /15-2 Nabe Ø 15x6	
	16	12,20	16	10	16	4	LS 16 T 2,5 /16-2 Nabe Ø 16x6	
	18	13,80	17	10	16	4	LS 16 T 2,5 /18-2 Nabe Ø 10x6	
	19	14,60	18	10	16	4	LS 16 T 2,5 /19-2 Nabe Ø 10x6	
	20	15,40	19	10	16	4	LS 16 T 2,5 /20-2 Nabe Ø 12x6	
	24	18,55	22	10	16	4	LS 16 T 2,5 /24-2 Nabe Ø 14x6	
	25	19,35	24	10	16	4	LS 16 T 2,5 /25-2 Nabe Ø 14x6	
	30	23,35	28	10	16	6	LS 16 T 2,5 /30-2 Nabe Ø 16x6	
	32	24,95	28	10	16	6	LS 16 T 2,5 /32-2 Nabe Ø 16x6	
	36	28,10	32	10	16	6	LS 16 T 2,5 /36-2 Nabe Ø 20x6	
	40	31,30	35	10	16	6	LS 16 T 2,5 /40-2 Nabe Ø 22x6	
	48	37,70	—	10	16	6	LS 16 T 2,5 /48-0 Nabe Ø 26x6	
	60	47,25	—	10	16	8	LS 16 T 2,5 /60-0 Nabe Ø 34x6	
	Belt width b = 10 mm	10	7,45	10	14	20	3	LS 20 T 2,5 /10-2 Nabe Ø 10x6
		12	9,00	13	14	20	3	LS 20 T 2,5 /12-2 Nabe Ø 12x6
		14	10,60	14	14	20	3	LS 20 T 2,5 /14-2 Nabe Ø 14x6
		15	11,40	15	14	20	3	LS 20 T 2,5 /15-2 Nabe Ø 15x6
16		12,20	16	14	20	4	LS 20 T 2,5 /16-2 Nabe Ø 16x6	
18		13,80	17	14	20	4	LS 20 T 2,5 /18-2 Nabe Ø 10x6	
19		14,60	18	14	20	4	LS 20 T 2,5 /19-2 Nabe Ø 10x6	
20		15,40	19	14	20	4	LS 20 T 2,5 /20-2 Nabe Ø 12x6	
24		18,55	22	14	20	4	LS 20 T 2,5 /24-2 Nabe Ø 14x6	
25		19,35	24	14	20	4	LS 20 T 2,5 /25-2 Nabe Ø 14x6	
30		23,35	28	14	20	6	LS 20 T 2,5 /30-2 Nabe Ø 16x6	
32		24,95	28	14	20	6	LS 20 T 2,5 /32-2 Nabe Ø 16x6	
36		28,10	32	14	20	6	LS 20 T 2,5 /36-2 Nabe Ø 20x6	
40		31,30	35	14	20	6	LS 20 T 2,5 /40-2 Nabe Ø 22x6	
48	37,70	—	14	20	6	LS 20 T 2,5 /48-0 Nabe Ø 26x6		
60	47,25	—	14	20	8	LS 20 T 2,5 /60-0 Nabe Ø 34x6		

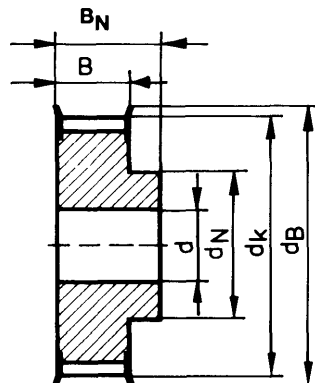

Type 2
inclusive up to
T 2,5 z = 40
T 2 / M z = 24 - 48
K 1,5 = 32

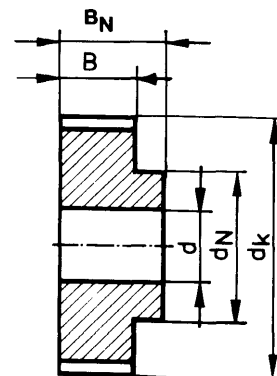

Type 0
T 2,5 from z = 48
T 2 / M up to z = 20
K 1,5 up to z = 24

Type	No. of teeth z	Outside diameter mm	d_B mm	Tooth width B mm	Total width B_N mm	Bored H7 without Keyway mm	Specification
T 5 Belt width b = 10 mm	10	15,05	20	15	21	4	LS 21 T 5 / 10-2 Nabe Ø 8x6
	12	18,25	23	15	21	4	LS 21 T 5 / 12-2 Nabe Ø 12x6
	14	21,45	26	15	21	6	LS 21 T 5 / 14-2 Nabe Ø 14x6
	15	23,05	28	15	21	6	LS 21 T 5 / 15-2 Nabe Ø 16x6
	16	24,60	30	15	21	6	LS 21 T 5 / 16-2 Nabe Ø 18x6
	18	27,80	33	15	21	6	LS 21 T 5 / 18-2 Nabe Ø 20x6
	19	29,40	34	15	21	6	LS 21 T 5 / 19-2 Nabe Ø 22x6
	20	31,00	36	15	21	6	LS 21 T 5 / 20-2 Nabe Ø 24x6
	24	37,40	42	15	21	6	LS 21 T 5 / 24-2 Nabe Ø 26x6
	25	39,00	43	15	21	6	LS 21 T 5 / 25-2 Nabe Ø 26x6
	27	42,20	47	15	21	8	LS 21 T 5 / 27-2 Nabe Ø 30x6
	30	46,95	51	15	21	8	LS 21 T 5 / 30-2 Nabe Ø 34x6
	32	50,10	55	15	21	8	LS 21 T 5 / 32-2 Nabe Ø 38x6
	36	56,45	61	15	21	8	LS 21 T 5 / 36-2 Nabe Ø 38x6
	40	62,85	67	15	21	8	LS 21 T 5 / 40-2 Nabe Ø 40x6
	48	75,55	—	15	21	8	LS 21 T 5 / 48-0 Nabe Ø 50x6
	60	94,65	—	15	21	8	LS 21 T 5 / 60-0 Nabe Ø 65x6
T 5 Belt width b = 16 mm	10	15,05	20	21	27	4	LS 27 T 5 / 10-2 Nabe Ø 8x6
	12	18,25	23	21	27	4	LS 27 T 5 / 12-2 Nabe Ø 12x6
	14	21,45	26	21	27	6	LS 27 T 5 / 14-2 Nabe Ø 14x6
	15	23,05	28	21	27	6	LS 27 T 5 / 15-2 Nabe Ø 16x6
	16	24,60	30	21	27	6	LS 27 T 5 / 16-2 Nabe Ø 18x6
	18	27,80	33	21	27	6	LS 27 T 5 / 18-2 Nabe Ø 20x6
	19	29,40	34	21	27	6	LS 27 T 5 / 19-2 Nabe Ø 22x6
	20	31,00	36	21	27	6	LS 27 T 5 / 20-2 Nabe Ø 24x6
	24	37,40	42	21	27	6	LS 27 T 5 / 24-2 Nabe Ø 26x6
	25	39,00	43	21	27	6	LS 27 T 5 / 25-2 Nabe Ø 26x6
	27	42,20	47	21	27	8	LS 27 T 5 / 27-2 Nabe Ø 30x6
	30	46,95	51	21	27	8	LS 27 T 5 / 30-2 Nabe Ø 34x6
	32	50,10	55	21	27	8	LS 27 T 5 / 32-2 Nabe Ø 38x6
	36	56,45	61	21	27	8	LS 27 T 5 / 36-2 Nabe Ø 38x6
	40	62,85	67	21	27	8	LS 27 T 5 / 40-2 Nabe Ø 40x6
	48	75,55	—	21	27	8	LS 27 T 5 / 48-0 Nabe Ø 50x6
	60	94,65	—	21	27	8	LS 27 T 5 / 60-0 Nabe Ø 65x6
T 5 Belt width b = 25 mm	10	15,05	20	30	36	6	LS 36 T 5 / 10-2 Nabe Ø 8x6
	12	18,25	23	30	36	6	LS 36 T 5 / 12-2 Nabe Ø 12x6
	14	21,45	26	30	36	6	LS 36 T 5 / 14-2 Nabe Ø 14x6
	15	23,05	28	30	36	6	LS 36 T 5 / 15-2 Nabe Ø 16x6
	16	24,60	30	30	36	6	LS 36 T 5 / 16-2 Nabe Ø 18x6
	18	27,80	33	30	36	6	LS 36 T 5 / 18-2 Nabe Ø 20x6
	19	29,40	34	30	36	6	LS 36 T 5 / 19-2 Nabe Ø 22x6
	20	31,00	36	30	36	6	LS 36 T 5 / 20-2 Nabe Ø 24x6
	24	37,40	42	30	36	8	LS 36 T 5 / 24-2 Nabe Ø 26x6
	25	39,00	43	30	36	8	LS 36 T 5 / 25-2 Nabe Ø 26x6
	27	42,20	47	30	36	8	LS 36 T 5 / 27-2 Nabe Ø 30x6
	30	46,95	51	30	36	8	LS 36 T 5 / 30-2 Nabe Ø 34x6
	32	50,10	55	30	36	8	LS 36 T 5 / 32-2 Nabe Ø 38x6
	36	56,45	61	30	36	8	LS 36 T 5 / 36-2 Nabe Ø 38x6
	40	62,85	67	30	36	8	LS 36 T 5 / 40-2 Nabe Ø 40x6
	48	75,55	—	30	36	8	LS 36 T 5 / 48-2 Nabe Ø 50x6
	60	94,65	—	30	36	8	LS 36 T 5 / 60-2 Nabe Ø 65x6

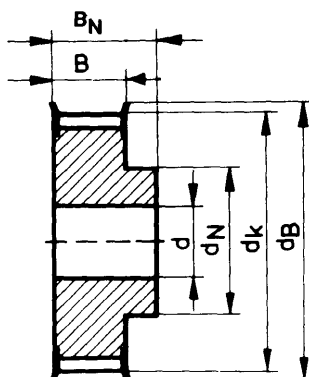

Type 2 inclusive up to z = 40

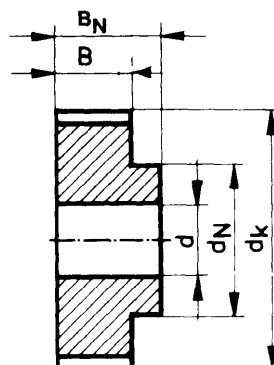

Type 0 from z = 48

Material: Al Cu Mg Pb

Type	No. of teeth z	Outside diameter mm	d_B mm	Tooth width B mm	Total width B_N mm	Bored H7 without Keyway mm	Specification	
T 10 Belt width b = 16 mm	12	36,35	42	21	31	6	LS 31 T 10 /12-2 Nabe \varnothing 28x10	
	14	42,70	48	21	31	8	LS 31 T 10 /14-2 Nabe \varnothing 32x10	
	15	45,90	51	21	31	8	LS 31 T 10 /15-2 Nabe \varnothing 32x10	
	16	49,05	55	21	31	8	LS 31 T 10 /16-2 Nabe \varnothing 35x10	
	18	55,45	61	21	31	8	LS 31 T 10 /18-2 Nabe \varnothing 40x10	
	19	58,60	64	21	31	8	LS 31 T 10 /19-2 Nabe \varnothing 44x10	
	20	61,80	67	21	31	8	LS 31 T 10 /20-2 Nabe \varnothing 46x10	
	24	74,55	80	21	31	8	LS 31 T 10 /24-2 Nabe \varnothing 58x10	
	25	77,70	82	21	31	8	LS 31 T 10 /25-2 Nabe \varnothing 60x10	
	27	84,10	90	21	31	8	LS 31 T 10 /27-2 Nabe \varnothing 60x10	
	30	93,65	99	21	31	8	LS 31 T 10 /30-2 Nabe \varnothing 60x10	
	32	100,00	105	21	31	10	LS 31 T 10 /32-2 Nabe \varnothing 65x10	
	36	112,75	118	21	31	10	LS 31 T 10 /36-2 Nabe \varnothing 70x10	
	40	125,45	131	21	31	10	LS 31 T 10 /40-2 Nabe \varnothing 80x10	
	48	150,95	—	21	31	16	LS 31 T 10 /48-2 Nabe \varnothing 95x10	
	60	189,10	—	21	31	16	LS 31 T 10 /60-0 Nabe \varnothing 110x10	
	Belt width b = 25 mm	12	36,35	42	30	40	6	LS 40 T 10 /12-2 Nabe \varnothing 28x10
		14	42,70	48	30	40	8	LS 40 T 10 /14-2 Nabe \varnothing 32x10
15		45,90	51	30	40	8	LS 40 T 10 /15-2 Nabe \varnothing 32x10	
16		49,05	55	30	40	8	LS 40 T 10 /16-2 Nabe \varnothing 35x10	
18		55,45	61	30	40	8	LS 40 T 10 /18-2 Nabe \varnothing 40x10	
19		58,60	64	30	40	8	LS 40 T 10 /19-2 Nabe \varnothing 44x10	
20		61,80	67	30	40	8	LS 40 T 10 /20-2 Nabe \varnothing 46x10	
24		74,55	80	30	40	8	LS 40 T 10 /24-2 Nabe \varnothing 58x10	
25		77,70	82	30	40	8	LS 40 T 10 /25-2 Nabe \varnothing 60x10	
27		84,10	90	30	40	8	LS 40 T 10 /27-2 Nabe \varnothing 60x10	
30		93,65	99	30	40	8	LS 40 T 10 /30-2 Nabe \varnothing 60x10	
32		100,00	105	30	40	10	LS 40 T 10 /32-2 Nabe \varnothing 65x10	
36		112,75	118	30	40	10	LS 40 T 10 /36-2 Nabe \varnothing 70x10	
40		125,45	131	30	40	10	LS 40 T 10 /40-2 Nabe \varnothing 80x10	
48		150,95	—	30	40	16	LS 40 T 10 /48-2 Nabe \varnothing 95x10	
60		189,10	—	30	40	16	LS 30 T 10 /60-0 Nabe \varnothing 110x10	
Belt width b = 32 mm		18	55,45	61	40	50	10	LS 50 T 10 /18-2 Nabe \varnothing 40x10
		19	58,60	64	40	50	10	LS 50 T 10 /19-2 Nabe \varnothing 44x10
	20	61,80	67	40	50	12	LS 50 T 10 /20-2 Nabe \varnothing 46x10	
	24	74,55	80	40	50	12	LS 50 T 10 /24-2 Nabe \varnothing 58x10	
	25	77,70	82	40	50	12	LS 50 T 10 /25-2 Nabe \varnothing 60x10	
	27	84,10	90	40	50	12	LS 50 T 10 /27-2 Nabe \varnothing 60x10	
	30	93,65	99	40	50	12	LS 50 T 10 /30-2 Nabe \varnothing 60x10	
	32	100,00	105	40	50	12	LS 50 T 10 /32-2 Nabe \varnothing 65x10	
	36	112,75	118	40	50	16	LS 50 T 10 /36-2 Nabe \varnothing 70x10	
	40	125,45	131	40	50	16	LS 50 T 10 /40-2 Nabe \varnothing 80x10	
	48	150,95	—	40	50	16	LS 50 T 10 /48-2 Nabe \varnothing 95x10	
	60	189,10	—	40	50	16	LS 50 T 10 /60-0 Nabe \varnothing 110x10	
Belt width b = 50 mm	18	55,45	61	56	66	10	LS 66 T 10 /18-2 Nabe \varnothing 40x10	
	19	58,60	64	56	66	10	LS 66 T 10 /19-2 Nabe \varnothing 44x10	
	20	61,80	67	56	66	12	LS 66 T 10 /20-2 Nabe \varnothing 46x10	
	24	74,55	80	56	66	12	LS 66 T 10 /24-2 Nabe \varnothing 58x10	
	25	77,70	82	56	66	12	LS 66 T 10 /25-2 Nabe \varnothing 60x10	
	27	84,10	90	56	66	12	LS 66 T 10 /27-2 Nabe \varnothing 60x10	
	30	93,65	99	56	66	12	LS 66 T 10 /30-2 Nabe \varnothing 60x10	
	32	100,00	105	56	66	12	LS 66 T 10 /32-2 Nabe \varnothing 65x10	
	36	112,75	118	56	66	16	LS 66 T 10 /36-2 Nabe \varnothing 70x10	
	40	125,45	131	56	66	16	LS 66 T 10 /40-2 Nabe \varnothing 80x10	
	48	150,95	—	56	66	16	LS 66 T 10 /48-2 Nabe \varnothing 95x10	
	60	189,10	—	56	66	16	LS 66 T 10 /60-0 Nabe \varnothing 110x10	

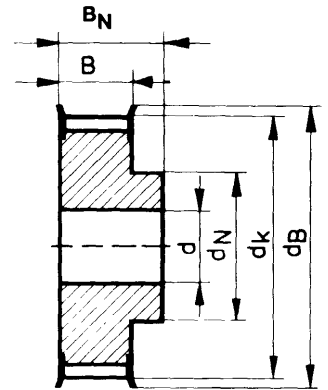

Type 2
inclusive up
to z = 40

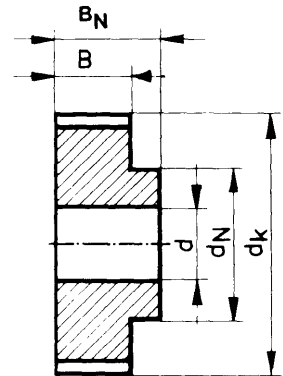

Type 0
from z = 48

Ordering example: Timing pulley T 10 for belt width 16 mm from stock.

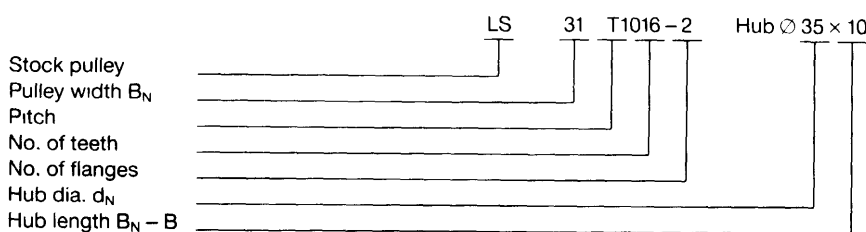

Type	No. of teeth z	Outside diameter mm	d_B mm	Tooth width B mm	Total width B_N mm	Bored H7 without Keyway mm	Specification	
AT 5	20	30,60	36	32	38	6	LS 38 AT 5 /20-2 Nabe \varnothing 24x6	
	22	33,85	39	32	38	6	LS 38 AT 5 /22-2 Nabe \varnothing 24x6	
	24	37,00	42	32	38	8	LS 38 AT 5 /24-2 Nabe \varnothing 26x6	
	25	38,60	43	32	38	8	LS 38 AT 5 /25-2 Nabe \varnothing 26x6	
	27	41,80	47	32	38	8	LS 38 AT 5 /27-2 Nabe \varnothing 30x6	
	Belt width b = 25 mm	30	46,55	51	32	38	8	LS 38 AT 5 /30-2 Nabe \varnothing 34x6
		32	49,70	55	32	38	8	LS 38 AT 5 /32-2 Nabe \varnothing 38x6
		36	56,05	61	32	38	8	LS 38 AT 5 /36-2 Nabe \varnothing 38x6
		40	62,45	67	32	38	8	LS 38 AT 5 /40-2 Nabe \varnothing 40x6
		44	68,80	74	32	38	8	LS 38 AT 5 /44-2 Nabe \varnothing 50x6
		48	75,15	—	32	38	8	LS 38 AT 5 /48-0 Nabe \varnothing 50x6
	60	94,25	—	32	38	8	LS 38 AT 5 /60-0 Nabe \varnothing 65x6	
	72	113,35	—	32	38	10	LS 38 AT 5 /72-0 Nabe \varnothing 80x6	
	AT 10	20	61,80	67	32	42	12	LS 42 AT 10 /20-2 Nabe \varnothing 46x10
22		68,15	74	32	42	12	LS 42 AT 10 /22-2 Nabe \varnothing 50x10	
24		74,55	80	32	42	12	LS 42 AT 10 /24-2 Nabe \varnothing 58x10	
25		77,70	82	32	42	12	LS 42 AT 10 /25-2 Nabe \varnothing 60x10	
27		84,10	90	32	42	12	LS 42 AT 10 /27-2 Nabe \varnothing 60x10	
Belt width b = 25 mm		30	93,65	99	32	42	12	LS 42 AT 10 /30-2 Nabe \varnothing 60x10
		32	100,00	105	32	42	12	LS 42 AT 10 /32-2 Nabe \varnothing 65x10
		36	112,75	118	32	42	16	LS 42 AT 10 /36-2 Nabe \varnothing 70x10
		40	125,45	131	32	42	16	LS 42 AT 10 /40-2 Nabe \varnothing 80x10
		44	138,20	144	32	42	16	LS 42 AT 10 /44-2 Nabe \varnothing 90x10
		48	150,95	—	32	42	16	LS 42 AT 10 /48-0 Nabe \varnothing 95x10
60		189,10	—	32	42	16	LS 42 AT 10 /60-0 Nabe \varnothing 110x10	
Belt width b = 50 mm		20	61,80	67	60	70	12	LS 70 AT 10 /20-2 Nabe \varnothing 46x10
		22	68,15	74	60	70	12	LS 70 AT 10 /22-2 Nabe \varnothing 50x10
		24	74,55	80	60	70	12	LS 70 AT 10 /24-2 Nabe \varnothing 58x10
		25	77,70	82	60	70	12	LS 70 AT 10 /25-2 Nabe \varnothing 60x10
		27	84,10	90	60	70	12	LS 70 AT 10 /27-2 Nabe \varnothing 60x10
		30	93,65	99	60	70	12	LS 70 AT 10 /30-2 Nabe \varnothing 60x10
		32	100,00	105	60	70	12	LS 70 AT 10 /32-2 Nabe \varnothing 65x10
		36	112,75	118	60	70	12	LS 70 AT 10 /36-2 Nabe \varnothing 70x10
		40	125,45	131	60	70	16	LS 70 AT 10 /40-2 Nabe \varnothing 80x10
		44	138,20	144	60	70	16	LS 70 AT 10 /44-2 Nabe \varnothing 90x10
48	150,95	—	60	70	16	LS 70 AT 10 /48-0 Nabe \varnothing 95x10		
60	189,10	—	60	70	16	LS 70 AT 10 /60-0 Nabe \varnothing 110x10		

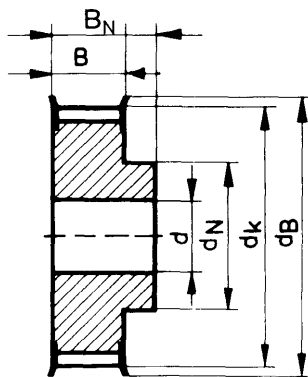

Type 2
inclusive up
to z = 40

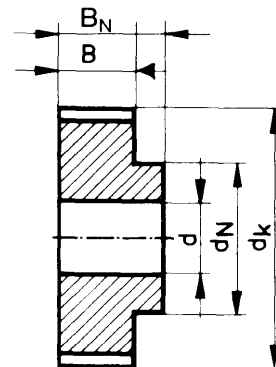

Type 0
from z = 48